



USB/NDI/IP PTZ Camera 12x Zoom, PoE

User Manual

500791-NDI



Table of Contents

1. Safety Precautions.....	3
2. Introduction.....	4
3. Features.....	4
4. Package Contents.....	4
5. Specifications.....	5
6. Product Connection.....	7
7. Video Format.....	7
8. About Product.....	8
8.1. Interface.....	8
8.2. Dimension.....	9
9. Installation Wall-Mount.....	10
10. Remote Control.....	11
11. OSD (On Screen Display) GUI Interface.....	12
11.1. Exposure.....	12
11.2. Color.....	13
11.3. Image.....	15
11.4. Display.....	16
11.5. P/T/Z Settings.....	16
11.6. Communication Setup.....	17
11.7. Tracking.....	18
11.8. Language.....	18
11.9. Default.....	19
11.10. Version.....	19
12. Web Settings.....	20
12.1. Control Camera.....	21
12.2. Video Settings.....	22
12.3. Tracking.....	23
12.4. Image Settings.....	32
12.5. Audio Settings.....	33
12.6. System Settings.....	33
12.7. Network Settings.....	34
12.8. NDI Settings (Optional).....	35
12.9. Overlay.....	36
12.10. Device Information.....	36
13. Troubleshooting.....	37

1. Safety Precautions

To ensure the best performance from the product, please read all instructions carefully before using the device. Save this manual for future reference.

- Follow basic safety precautions to reduce the risk of fire, electrical shock, and injury.
- Do not dismantle the housing or modify the module. It may result in electrical shock or burns.
- Do not open or remove the housing of the device as you may be exposed to dangerous voltage or other hazards.
- To prevent fire or shock hazard, do not expose the unit to rain, moisture and do not install this product near water. Keep the product away from liquids.
- Spillage into the housing may result in fire, electrical shock, or equipment damage. If an object or liquid falls or spills on the housing, unplug the module immediately.
- Do not use liquid or aerosol cleaners to clean this unit. Always unplug the power to the device before cleaning.
- Using supplies or parts not meeting the product specifications may cause damage, deterioration or malfunction.
- Refer all servicing to qualified service personnel.
- Install the device in a place with adequate ventilation to avoid damage caused by overheat.
- Unplug the power when left unused for a long period of time.
- Information on disposal of devices: do not burn or mix with general household waste, please treat them as normal electrical waste.

Copyright Notice

All contents in this manual are copyrighted, and cannot be cloned, copied, or translated without the express permission of MuxLab Inc. Product specifications and information in this document are for reference only, and the content may be updated from time to time without prior notice.

2. Introduction

The MuxLab USB/NDI/IP PTZ Camera 12X Zoom, PoE (model: 500791-NDI) is a full HD 1080p HDMI, USB and IP streaming camera with Pan, Tilt, and Zoom capability for extreme flexibility and reach. The camera supports uncompressed video via an HDMI or USB output for local connectivity, and H.264/H.265 compressed video for streaming over the Internet, while supporting a 12X optical zoom.

The USB/NDI/IP PTZ Camera 12X Zoom, PoE features an advanced AI algorithm that allows it to provide precise body tracking, supports PoE for convenience when powering the device, and a 1/2.8", 2.07 million effective pixels high-quality CMOS sensor to capture video. The camera supports a focal length of f3.5mm to 42.3mm, an aperture of F1.8 to 2.8, a shutter speed of 1/30s to 1/10000s, and a minimum illumination of 0.05 Lux for low-light conditions.

The USB/NDI/IP PTZ Camera 12X Zoom, PoE may be remotely managed via IP and RS232 for added convenience.

3. Features

- Maximum resolution of 1920 x 1080 (Full HD) at 60Hz
- Supports SDI, HDMI, USB 3.0 and network audio-visual output
- Built-in advanced AI algorithm that enables precise body tracking
- Supports 12x optical zoom and 72.5° horizontal field of view
- Supports Full NDI protocol
- Advanced Auto-focusing Technology
- Built-in dual microphone to capture sound
- Provides an economical solution for live streaming, conferencing and education.

4. Package Contents

- One (1) USB/NDI/IP PTZ Camera 30x Zoom.
- One (1) 100~240V AC 50/60Hz 24V-6.5A Power adapter
- One (1) RS232 Cable
- One (1) Remote Control
- One (1) Wall mount Bracket
- User Manual can be downloaded from MuxLab website.

Notes: Confirm that the product and accessories are all included. If not, please contact the supplier from which you purchased the unit.

5. Specifications

Camera	
Video System (HDMI, 3G-SDI)	1080P60, 1080P59.94, 1080P50, 1080I60, 1080I59.94, 1080I50, 1080P30, 1080P29.97, 1080P25, 720P60, 720P59.94, 720P50
Sensor	1/2.8 inches, CMOS, Effective Pixels: 2.07 Megapixels
Scanning Mode	Progressive
Lens	12x, f3.5mm ~ 42.3mm, F1.8 ~ F2.8
Minimal Illumination	0.5Lux @ (F1.8, AGC ON)
Electronic Shutter	1/30s ~ 1/10000s
White Balance	Auto, Indoor, Outdoor, One Push, Manual, VAR
Digital Noise Reduction	2D, 3D digital noise reduction
Backlight Compensation	Supported
SNR	≥55dB
Horizontal Angle of View	72.5° ~ 6.9°
Vertical Angle of View	44.8° ~ 3.9°
Horizontal Rotation Range	±170°
Vertical Rotation Range	-30° ~ +90°
Pan Speed Range	1.7° ~ 100°/s
Tilt Speed Range	1.7° ~ 69.9°/s
H & V Flip	Supported
Image Freeze	Supported
Number of Presets	255
Preset Accuracy	0.1°
Audio	
Microphone Array	Built-in dual microphone, 100Hz to 16KHz frequency response
Analog Audio Input	Supported 3.5mm Line-In
Digital audio output	Supported HDMI, USB, LAN, 3G-SDI
Analog audio output	Supported 3.5mm Line-Out
USB Feature	
Operating System	Windows® 7, Windows 8.1, Windows 10 and up macOS™ 10.10 and up Google™ Chromebook™ Version 29.0.1547.70 and up Linux (only for UVC)
Hardware Requirement	2.4 GHz Intel® Core 2 Duo processor and up 2 GB internal storage and up USB 2.0 interface
Color System / Compression	YUY2/MJPEG/H.264
Video Format	video format of multi frame rate and resolution ratio, up to 1080P60 YUY2.
USB Video Communication Protocol	UVC 1.1 or UV C1.5
Audio on USB	32K sampling frequency, supported UAC2.0
UVC PTZ Control	Supported

IP Camera	
Video Compression	H.264
Video Stream	First and second streaming
Main Stream Resolution	1920x1080, 1280x720, 1024x576, 960x540, 640x480, 640x360
Sub Stream Resolution	1280x720, 1024x576, 720x576, 720x480, 720x408, 640x360, 480x270, 320x240, 320x180
Video Bit Rate	32Kbps ~ 102400Kbps
Bit Rate Control	VBR, CBR
frame rate	1fps ~ 60fps
Audio Compression	AAC
Audio Bit Rate	96Kbps, 128Kbps, 256Kbps
Supported protocols	FULL NDI, NDI HX, TCP/IP, HTTP, RTSP, RTMP, Onvif, DHCP, Multicast, SRT, GB/T28281
Input/Output Interface	
USB	1-ch, USB 3.0: Type-A
HD Output	1 x HDMI: V 1.3
Network Interface	1 x 3G-SDI: BNC type, 800mVp-p, 75Ω, Comply with SMPTE 424M standard 1 x RJ45:10M/100M/1000M Adaptive Ethernet, supported PoE
Audio interface	1 x Line In, 3.5mm Jack 1 x Line Out, 3.5mm Jack
Control Interface	1 x RS232 In: 8pin Min DIN, Max Distance: 30m, VISCA/Pelco-D/Pelco-P 1 x RS232 Out: 8pin Min DIN, Max Distance: 30m, Protocol: VISCA only 1 x RS485: 2pin phoenix port, Max Distance: 1200m, VISCA/Pelco-D/Pelco-P
Power Jack	JEITA Type (Input 12VDC)
Generic Specification	
Input Voltage	12VDC, PoE (802.3af)
Input Current	1.5A (Max)
Operating Temperature	0°C ~ 40°C
Storage Temperature	-10°C ~ 50°C
Power Consumption	15W
Size	169mm x 142mm x 175mm
Net Weight	1.5Kg
Warranty	2 years
Order Information	500791-NDI USB/NDI/IP PTZ Camera 12x Zoom, PoE (UPC: 627699027912)

6. Product Connection

1. Please check connections are correct before starting.

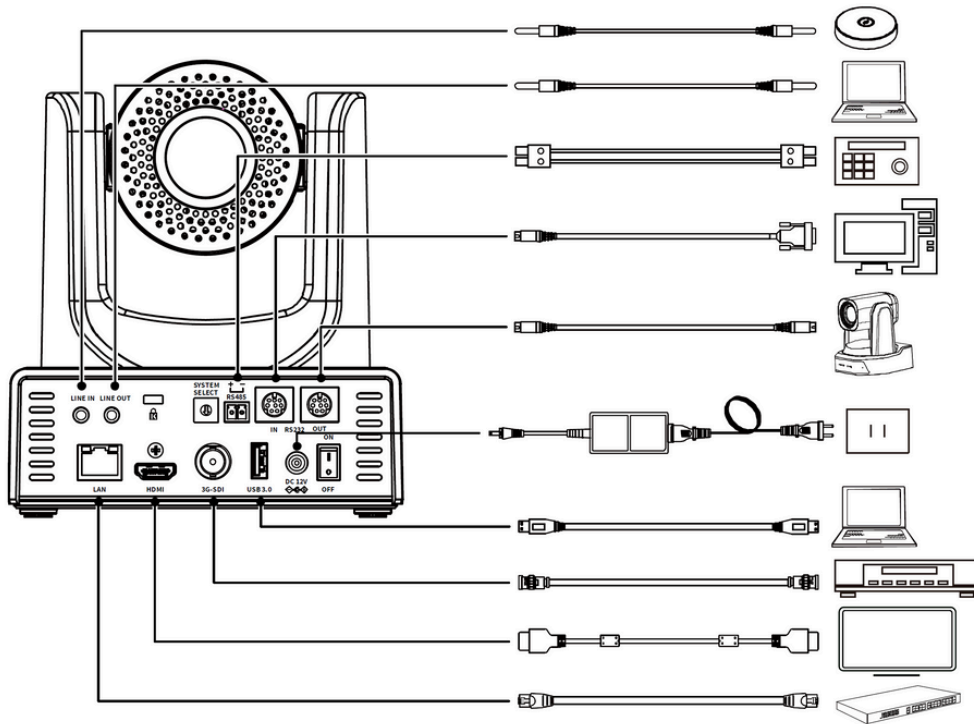

The schematic diagram is for reference only. Please refer to the actual application scenario for product connection.

2. After the camera is powered on, it starts to initialize, right up to the limit position, and then both horizontal and vertical go to the middle position, the motor stops running, and the initialization is completed.
 (**Note:** If preset 0 is saved, PTZ will be move to preset 0)

7. Video Format

Video Format			
0	1080P60	8	-
1	1080P50	9	-
2	1080I60	A	1080P59.94
3	1080I50	B	1080I59.94
4	720P60	C	1080P29.97
5	720P50	D	-
6	1080P30	E	-
7	1080P25	F	720P59.94

Note: After switching the video format, you need to restart the camera before taking effect!

8. About Product

8.1 Interface

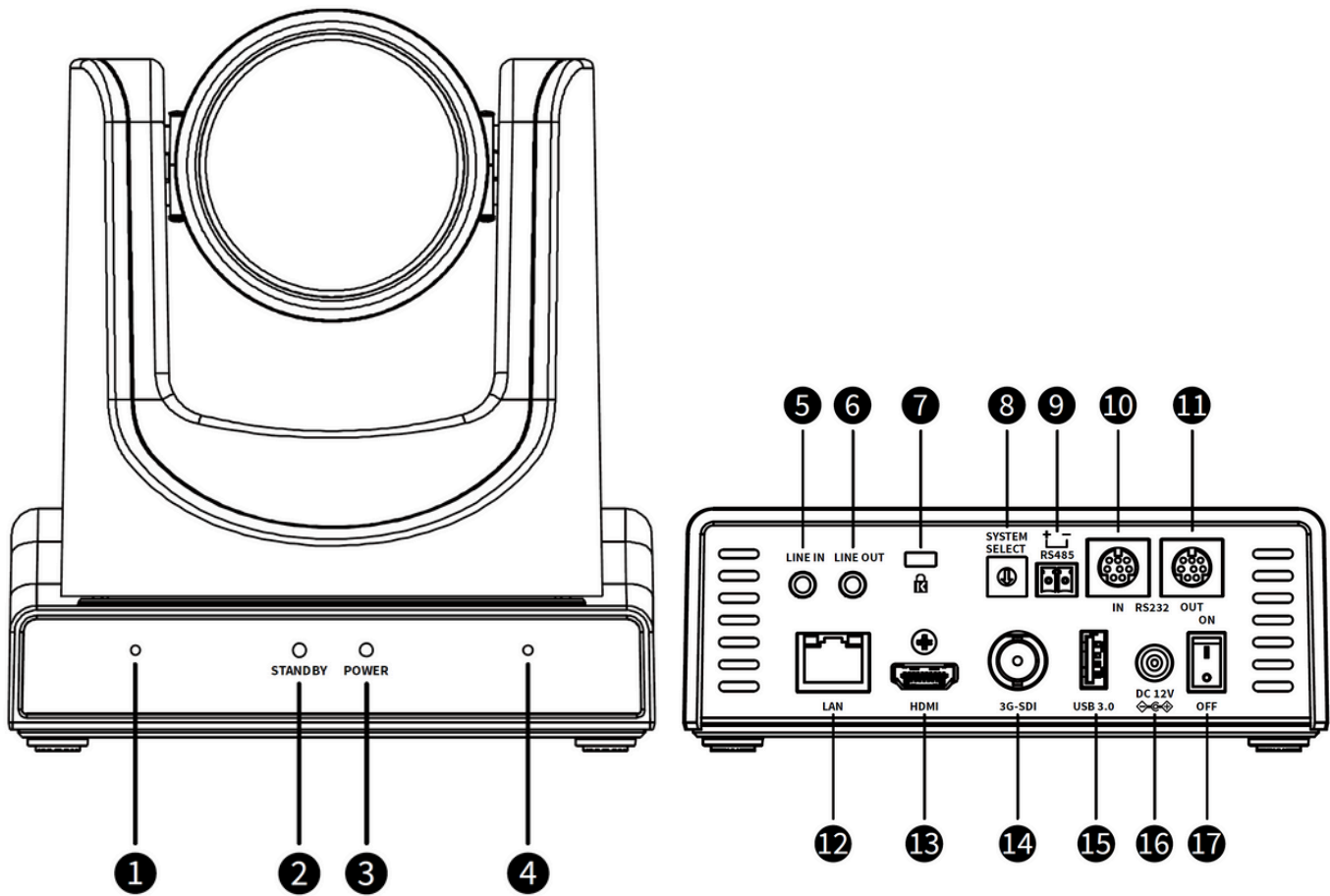

No	Name
1	Microphone
2	STANDBY Indicator
3	POWER Indicator
4	Microphone
5	LINE IN Interface
6	LINE OUT Interface
7	Security Slot
8	System Select Switch
9	RS485 Interface
10	RS232 IN Interface
11	RS232 OUT Interface
12	LAN Interface
13	HDMI Interface
14	3G-SDI Interface
15	USB 3.0 Interface
16	12VDC Power Interface
17	Power Switch

8.2 Dimension

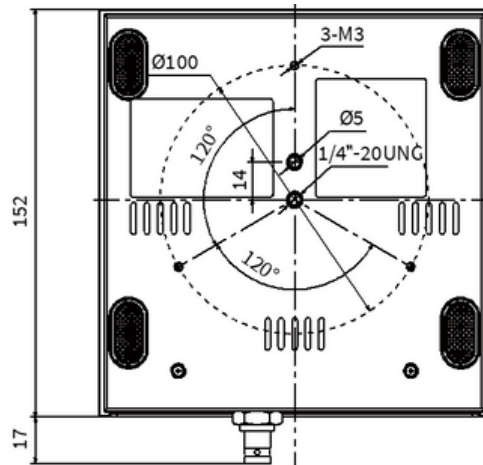
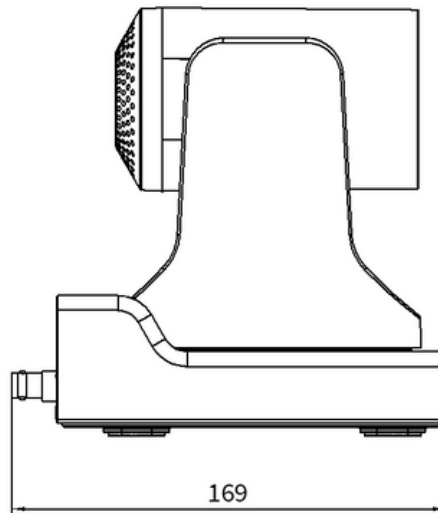
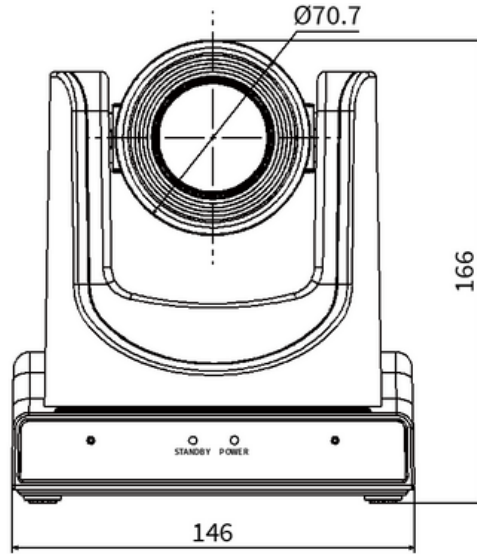

9. Installation Wall-Mount

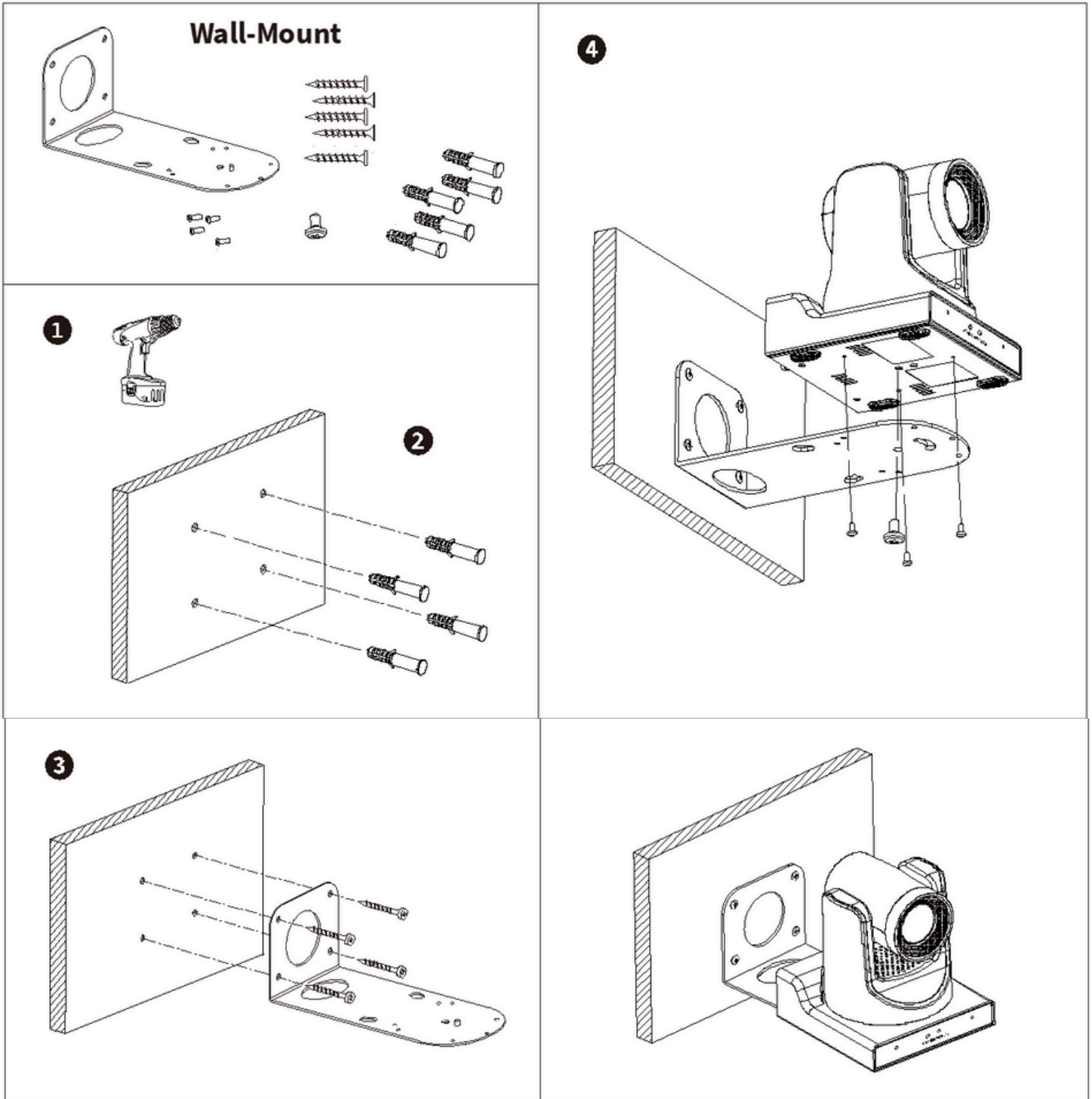

10. Remote Control

Key Description

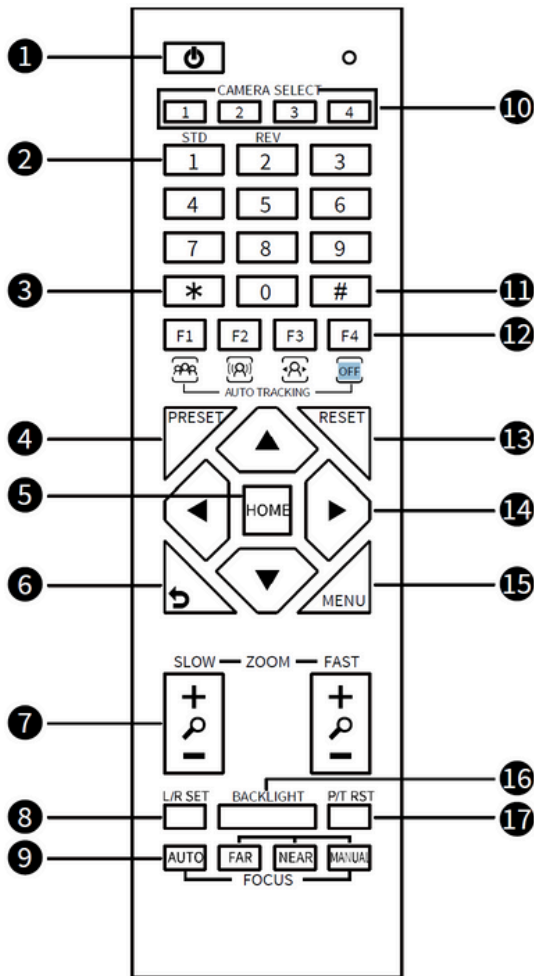

1. **Standby Key:** Press to enter standby mode
2. **Number Key:** Press to set preset or call preset
3. *** Key:** Use with other keys
4. **PRESET Key:** Set preset: [PRESET] + Number key (0-9)
5. **HOME Key:** Confirm selection or press to turn PTZ back to the middle position.
6. **Return Key:** Press to return to the previous menu
7. **ZOOM Key:** SLOW: Zoom In [+] or Zoom Out [-] slowly
FAST: Zoom In [+] or Zoom Out [-] fast
8. **L/R SET Key:** Standard: Simultaneously press L/R SET + 1
Reverse: Simultaneously press L/R SET + 2
9. **FOCUS Key:** Auto/Manual/Far/Near focus
10. **Camera Select Key:** Press to select and control the camera
11. **# Key:** Use with other keys
12. **Auto Tracking Keys:** [F1]: Disable
[F2]: Disable
[F3]: Enable AI Tracking
[F4]: Disable AI Tracking
13. **RESET Key:** Clear preset position: [RESET] + Number key (0-9)
14. **PTZ Control Key:** PTZ moved according to the arrow indicates

15. **MENU Key:** Press to enter or exit OSD (On Screen Display) Menu

16. **BACKLIGHT Key:** Backlight ON/OFF: Press repeatedly to enable or disable the backlight compensation.

NOTE: Effective only in auto exposure mode; If there is a light behind the subject, the subject will become dark, press the backlight key to enable the backlight compensation. Press again to disable this function.

17. **P/T RST (PTZ Reset) Key:** PTZ starts to self-test after pressing it.

Shortcut Set

- [*]+[#]+[1]: OSD menu default English
- [*]+[#]+[3]: OSD menu default Chinese
- [*]+[#]+[4]: Display current IP address
- [*]+[#]+[6]: Quickly recover the default
- [*]+[#]+[8]: View the camera version
- [*]+[#]+[9]: Quickly set up inversion
- [*]+[#]+[MANUAL]: Restore default IP address.

11. OSD (On Screen Display) GUI Interface

Press [MENU] key to display the main menu on the normal screen, using arrow key to move the cursor to the item to be set. Press the [HOME] key to enter the corresponding sub-menu.

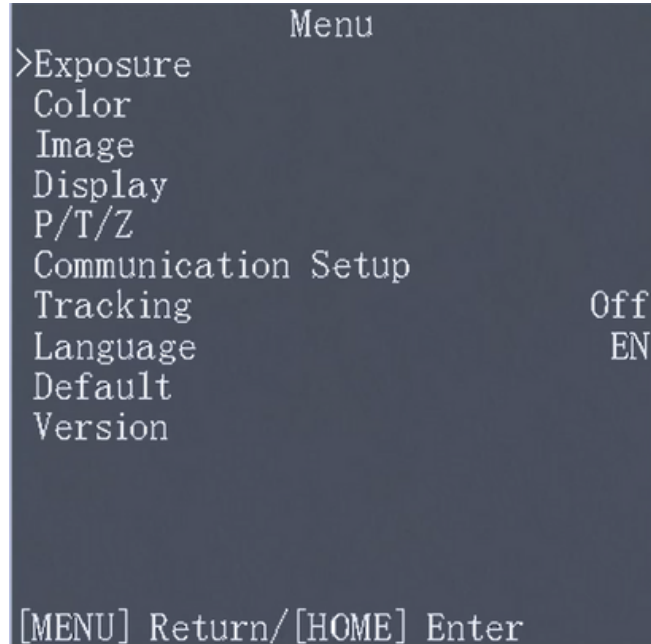

11.1 Exposure

Move the cursor to the Exposure submenu in the main menu and press the [home] button, the EXPOSURE submenu will appear as shown in the following figure.

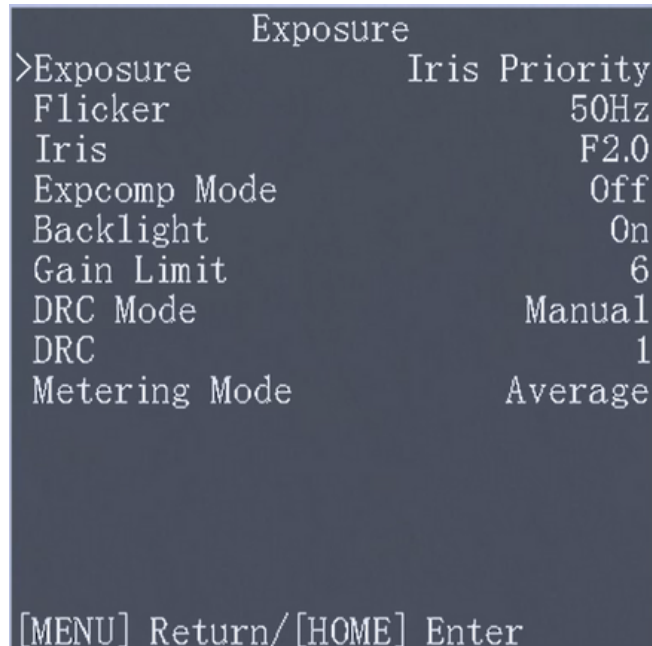

In the Exposure option there are five modes: Manual, Auto, Iris Priority, Shutter Priority and Bright Priority.

Manual Mode:

- **Iris:** F1.8, F2.0, F2.4, F2.8, F3.4, F4.0, F4.8, F5.6, F6.8, F8.0, F9.6, F11, Close.
- **Shutter:** 1/30, 1/50, 1/60, 1/90, 1/100, 1/125, 1/180, 1/250, 1/350, 1/500, 1/725, 1/1000, 1/1500, 1/2000, 1/3000, 1/4000, 1/6000, 1/10000.
- **Gain:** 0~31.
- **DRC Mode:** Manual, Auto, Off.
- **DRC:** 0~14.

Auto Mode:

- **Flicker:** Off, 50Hz, 60Hz.
- **Expcomp Mode:** On, Off.
- **Expmode:** -8~7.
- **Backlight:** On, Off.
- **Gain Limit:** 0~10.
- **DRC Mode:** Manual, Auto, Off.
- **DRC:** 0~14.
- **Matering Mode:** Average, Bottom, Center, Top.

11.2 Color

Move the main menu cursor to [Color], and press [HOME] key to enter the color page, as shown in the following figure.

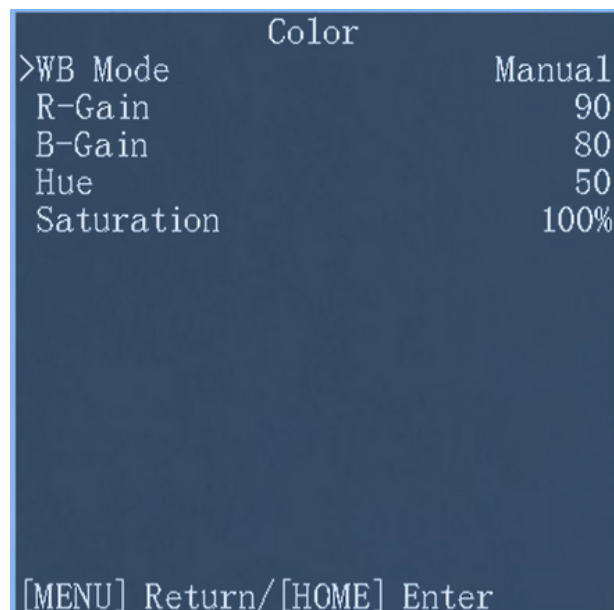

WB Mode: Auto, Temp, Manual, One Push, Indoor, Outdoor.

Auto

- **AWB Sens:** Low, Middle, High.
- **R-Tuning:** -128~127.
- **B-Tuning:** -128~127.
- **Hue:** 0~99.
- **Saturation:** 0~200%.

Temp

- **R-Tuning:** -128 ~ 127.
- **B-Tuning:** -128 ~ 127.
- **Color Temp:** 2000K ~ 8500K
- **Hue:** 0 ~ 99.
- **Saturation:** 60 ~ 200%.

Manual

- **R-Gain:** 0 ~ 255.
- **B-Gain:** 0 ~ 255.
- **Hue:** 0~99.
- **Saturation:** 60 ~ 200%.

One Push

- **Start Calc**
- **R-Tuning:** -128 ~ 127.
- **B-Tuning:** -128 ~ 127.
- **R-Gain:** 0 ~ 255.
- **B-Gain:** 0 ~ 255.
- **Color Temp:** 2000K ~ 8500K
- **Hue:** 0 ~ 99.
- **Saturation:** 60 ~ 200%.

Indoor

- **R-Tuning:** -128 ~ 127.
- **B-Tuning:** -128 ~ 127.
- **Hue:** 0 ~ 99.
- **Saturation:** 60 ~ 200%.

Outdoor

- **R-Tuning:** -128 ~ 127.
- **B-Tuning:** -128 ~ 127.
- **Hue:** 0 ~ 99.
- **Saturation:** 60 ~ 200%.

11.3 Image

Move the cursor to the Image submenu in the main menu and press the [home] button. The IMAGE submenu will appear as shown in the following figure.

```

                                Image
>Style                           Default
Brightness                         52
Contrast                           62
Sharpness Mode                      Auto
Gamma Mode                          Manual
Gamma                               0.5
NR-2D Mode                          Manual
NR-2D                               10
NR-3D Mode                          Auto
PF Correction Mode                  Off

[MENU] Return/[HOME] Enter

```

- **Style:** Default, HLG, Cold, Warm, Clear, Soft, Education, User1, User2, User3.
- **Brightness:** 16 ~ 99.
- **Contrast:** 16 ~ 99.
- **Sharpness Mode:** Manual, Auto.
- **Sharpness:** 0 ~ 76 (Effective only in Sharpness Mode to Manual).
- **Gamma Mode:** Manual, Auto.
- **Gamma:** Ext, HLG, 0.45, 0.5, 0.54, 0.56, 0.63 (Effective only in Gamma Mode to Manual).
- **NR-2D Mode:** Manual, Auto.
- **NR-2D:** 0 ~ 99 (Effective only in NR-2D Mode to Manual).
- **NR-3D Mode:** Manual, Auto.
- **NR-3D:** 0 ~ 15 (Effective only in NR-3D Mode to Manual).
- **PF Correction Mode:** ON, OFF (Effective only in NR-3D Mode to Manual).
- **PF Correction Level:** 0 ~ 15 (Effective only in PF Correction Mode to ON).

11.4 Display

Move the cursor to the Display submenu in the main menu and press the [home] button. The Display submenu will appear as shown in the following figure.

```

Display
>OSD-Dir          0
Frac Rate         Off
Video Format       1080P60
DVI Mode          HDMI
SDI Mode          Level A
Flip-H            Off
Flip-V            Off
Freeze at calling preset Off
Save isp param at preset Off
Display Info      On
GDC               Off

[MENU] Return/[HOME] Enter

```

- **OSD-Dir:** 0, 90, 180, 270.
- **Frac Rate:** On, Off.
- **Video Format:** 720P60, 720P50, 1080P30, 1080P25, 1080P60, 1080P50, 1080I60, 1080I50,
- **HDMI Mode:** HDMI, DVI.
- **SDI Mode:** Level A, Level B.
- **Flip-H:** On, Off.
- **Flip-V:** On, Off.
- **Freeze at calling preset:** On, Off.
- **Save isp param at preset:** On, Off
- **Display Info:** On, Off
- **GDC:** On, Off

11.5 P/T/Z Settings

Move the cursor to the P/T/Z submenu in the main menu and press the [home] button. The P/T/Z submenu will appear as shown in the following figure.

```

                                P/T/Z
>AF Sens                        Middle
AF Region                       Front
AF Limit                         Off
LR Mode                          STD
Motion Sync                      Off
PTZ Speed Setting   Preset Speed
Horizontal Speed                 23
Vertical Speed                   19
Zoom Speed                       7
PTbyZoom                        On
Digital Zoom                     Off

[MENU] Return/[HOME] Enter

```

- **AF-Sense:** High, Middle, Low.
- **AF Region:** Front, Top, Center, Bottom.
- **AF Limit:** On, Off
- **Near Limit:** 1M, 1.5M, 2M, 3M, 4M, 5M, 6M, 8M, 10M, 15M, 20M (Effective only in AF Limit to On).
- **FAR LIMIT:** 1.5M, 2M, 3M, 4M, 5M, 6M, 8M, 10M, 15M, 20M, Infinity (Effective only in AF Limit to On).
- **LR Mode:** STD, REV.
- **Motion Sync:** On, Off.
- **PTZ Speed Setting:** Preset Speed, Custom Speed
- **Custom Speed:** On, Off (Effective only in PTZ Speed Setting to Custom Speed).
- **Horizontal Speed:** 0 ~ 23.
- **Vertical Speed:** 0 ~ 19.
- **Zoom Speed:** 0 ~ 7.
- **PTbyZoom:** On, Off.
- **Digital Zoom:** 2x, 4x, 8x, 16x, Off

11.6 Communication Setup

Move the cursor to the Communication Setup submenu in the main menu and press the [home] button. The Communication Setup submenu will appear as shown in the following figure.

```

Communication Setup
>Visca Addr          3
Visca AddrFix       Off
Visca Mode          Serial
PELCO-D Addr        1
PELCO-P Addr        0
Baud Rate           9600
USB MODE            isoc
USB 3.0 Function    UVC
DHCP                Off
IP Addr             192.168.168.172
MAC                 d4e08ea2bf87

[MENU] Return/[HOME] Enter

```

- **Visca Addr:** 1 ~ 7.
- **Visca AddrFix:** On, Off
- **Visca Mode:** Serial, Para
- **PELCO-D Addr:** 0 ~ 254
- **PELCO-P Addr:** 0 ~ 31
- **Baud Rate:** 2400, 4800, 9600, 19200, 38400, 57600, 115200.
- **USB MODE:** isoc, bulk
- **USB 3.0 Function:** UVC
- **DHCP:** On, Off.
- **IP Addr:** 192.168.100.88.
- **MAC:** d4e08e548d13.

11.7 Tracking

Move the cursor to the Tracking option in the main menu and press the [▶] button to select one of the following tracking options: Auto Frame, Zone, Presenter or Off.

11.8 Language

Move the cursor to the Language option in the main menu and press the [▶] button to select one of the following language options: .English and Chinese

11.9 Default

Move the cursor to the Default submenu in the main menu and press the [home] button. The Default submenu will appear as shown in the following figure.

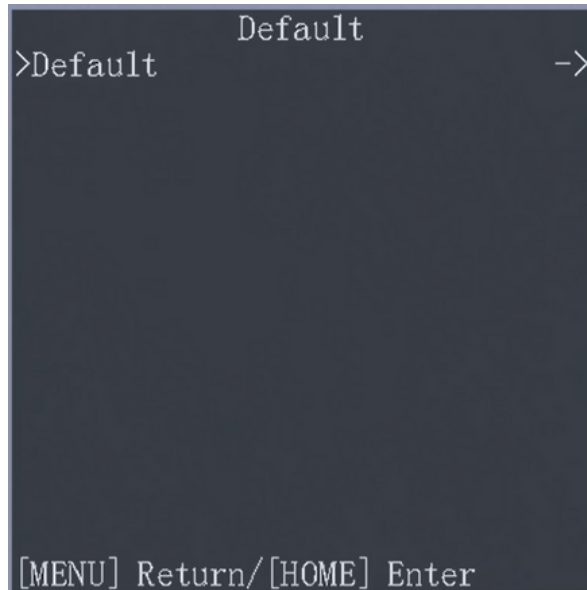

Press the Home button to set the factory default settings.

11.10 Version

Move the cursor to the Version submenu in the main menu and press the [home] button. The Default submenu will appear as shown in the following figure.

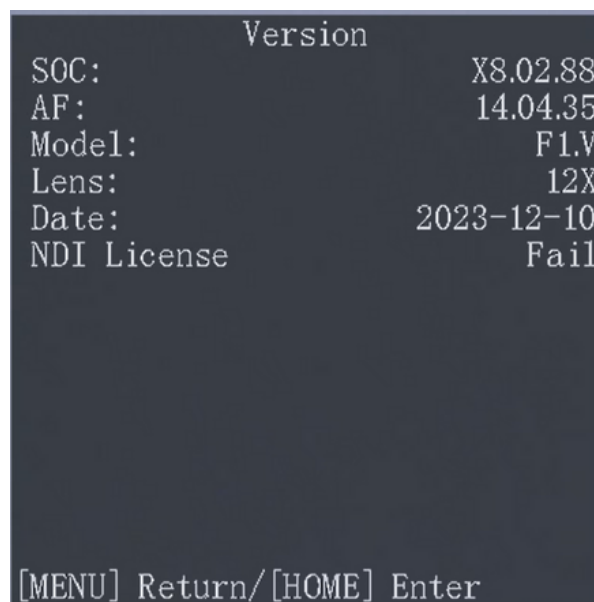

This submenu displays the camera's main software version recording date, camera autofocus version number, NDI license verification (if applicable), and other information.

12. Web Settings

Access <http://192.168.100.88> to pop up the login window, then input username (default: admin) and password (default: admin). After login, it will show as below:

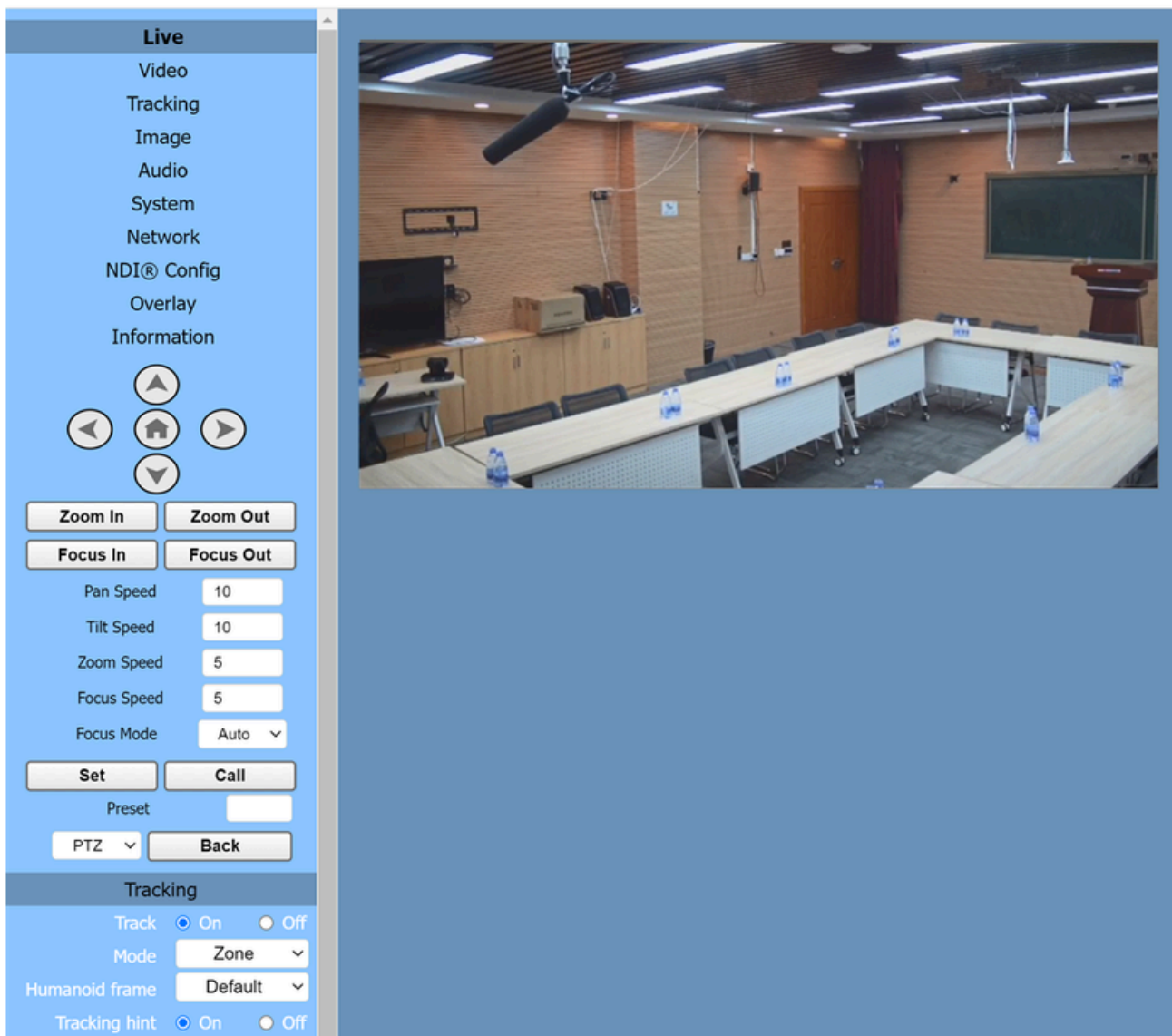

The screenshot displays the web interface for the PTZ camera. On the left is a control panel with the following sections:

- Live**: A menu with options: Video, Tracking, Image, Audio, System, Network, NDI® Config, Overlay, and Information.
- Navigation: Four directional arrow buttons (Up, Down, Left, Right) and a Home button.
- Zoom: **Zoom In** and **Zoom Out** buttons.
- Focus: **Focus In** and **Focus Out** buttons.
- Speeds: Sliders for Pan Speed (10), Tilt Speed (10), Zoom Speed (5), and Focus Speed (5).
- Focus Mode: A dropdown menu set to **Auto**.
- Buttons: **Set** and **Call** buttons.
- Preset: A text input field.
- PTZ: A dropdown menu and a **Back** button.
- Tracking**: A section with **Track** (radio buttons for On and Off), **Mode** (dropdown set to Zone), **Humanoid frame** (dropdown set to Default), and **Tracking hint** (radio buttons for On and Off).

On the right is a live video feed showing a conference room with a large U-shaped table, chairs, water bottles, a blackboard, and a PTZ camera mounted on the ceiling.

12.1 Control Camera

There are two sections on the home page.

- Real time monitoring: displaying video image.
- Parameter setup: with function buttons.

A. Video Viewing Window

Video viewing window must be same as video resolution, the bigger the resolution is, the bigger the playing area is. Double click viewing window, will show full-screen, double click again, will return to initialized size.

B. PTZ Setup

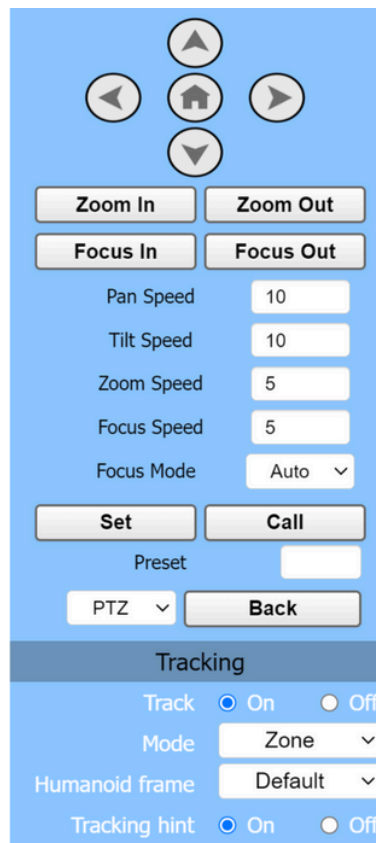

- 1) **Pan and Tilt Control:** Up, Down, Left and Right arrows and the home button allow you to manually drive the camera to the desired position.
- 2) **Zoom:** Zoom In and Zoom Out buttons allow for wide or narrow view of the space.
- 3) **Focus:** Focus In and Focus Out buttons allow for fine manual focus adjustment if the camera has any problems auto focusing on the difficult object.
- 4) **PTZ Speeds:** Pan speed can be set at any rate between 1 ~ 24, Tilt speed can be set at any rate between 1 ~ 20. Zoom and Focus speeds can be set at any rate between 1 ~ 7.

5) **PTZ Presets:** After manually setting up a shot that you would like to return to later, you can save presets for quick recall of these positions. Type a number between 0 and 254 into the Preset box. Click the "Set" button to save the current location with that preset number. Click the "Call" button to cause the camera to return to that position. This enables smooth, quick and convenient control without the need to manually drive the camera. You can set up preset that user want as below.

Method: Type preset number into the Preset box.



Preset: Optional items: 0 ~ 254.

- 6) **PTZ/OSD Dropdown:** From the dropdown menu, clicking the OSD option will open the on-screen display menu of the camera giving you control from within the IP interface.
- 7) **Tracking:** By modifying tracking parameters, different close-up ratios can be obtained, and tracking can be set on/off, so as to display areas and character positions. If necessary, you can also choose whether to display tracking related prompt information.

12.2 Video Settings

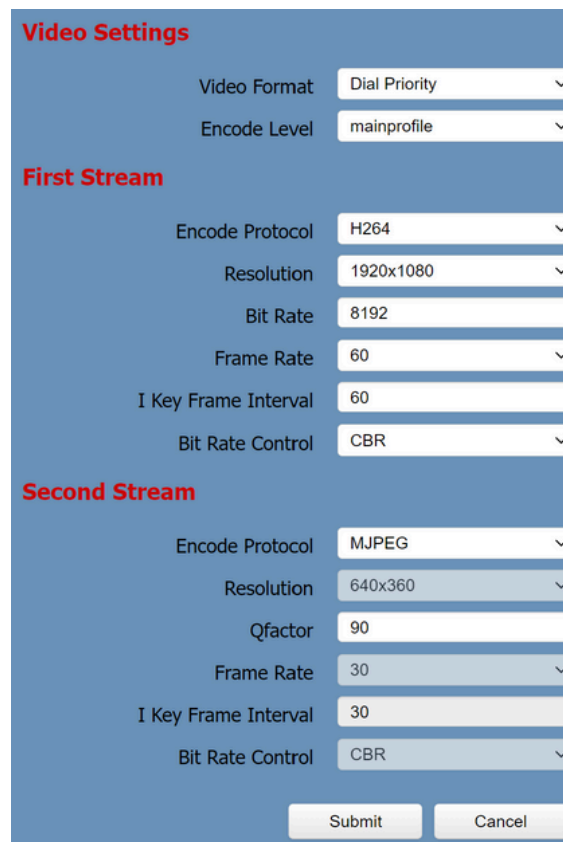

- 1) **Video Format:** Supports Dial Priority, 50Hz and 60Hz.
- 2) **Encode Level:** Supports baseline, main profile, high profile and svc-t.
- 3) **Encode Protocol:** Supports H.264, H.265 and MJPEG protocols.
- 4) **Resolution:** First stream support 1920x1080, 1280x720, 1024x576, 960x540, 640x480, 640x360. Second stream support 1280x720, 1024x576, 720x480, 640x360, 480x272, 320x240, 320x180; The bigger resolution is, the clearer the image will be, more network bandwidth will be taken.
- 5) **Bit Rate:** The user can specify the bit rate. Generally speaking, the larger of the bit rate, the clearer of the image. However, the configuration of the bit rate needs to be combined with the network bandwidth. When the network bandwidth is narrow and the bit rate is configured larger, the video stream cannot be transmitted normally, and the visual effect is worse.
- 6) **Frame Rate:** User can specify the size of the frame rate, generally, the frame rate greater, the image more smooth; Frame rate is smaller, the more sense of beating.
- 7) **I Key Frame Interval:** Set interval between 2 I frame, the bigger interval is the response will be lower from viewing window.
- 8) **Bit Rate Control:**
Code stream control way:
CBR (Constant Bit Rate): Video coder will be coding according to preset speed.
VBR (Variable Bit Rate): Video coder will adjust the speed based on preset speed to gain the best image quality.

12.3 Tracking

In this tab, the user can get different close-up ratios and tracking can be set on/off, so as to display areas and character positions. If necessary, you can also choose whether to display tracking related prompt information.

Step 1: Enter the "Tracking" option, select speaker mode "Presenter", and set the tracking parameters in the "Track Off" state.

Tracking Mode: Speaker (Presenter)/Area (Zone)

The default is Presenter Mode.

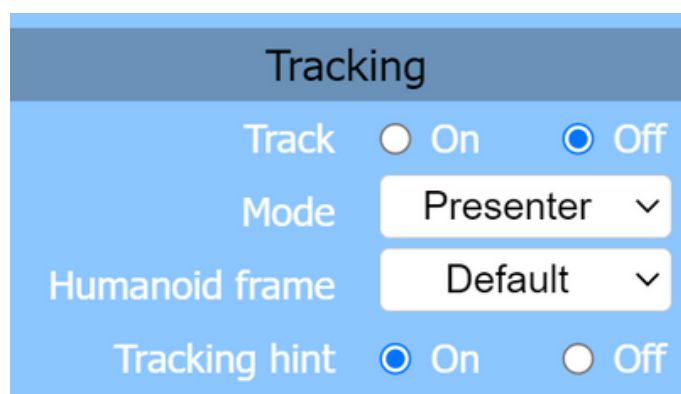

Step 2: We can consider how long the Target Retention Time will take, with a default of 6 seconds and a maximum of 10 seconds.

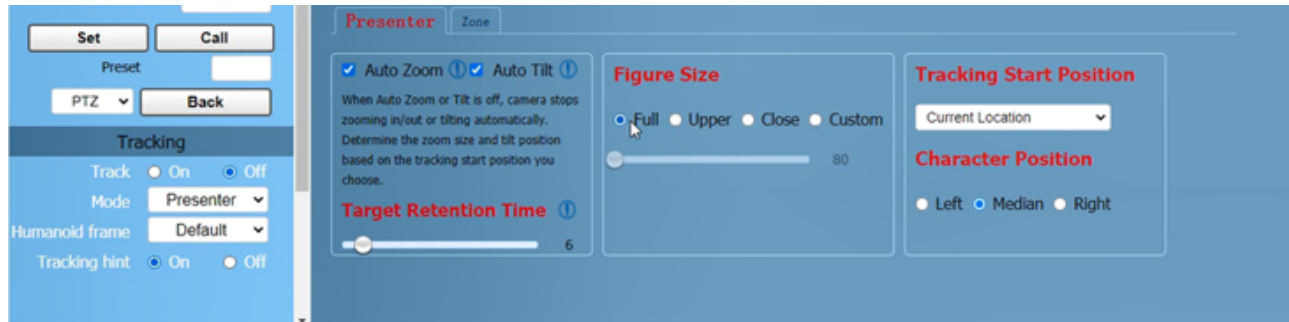

Auto Zoom: Usually remains the default. When “Auto Zoom” is turned off, the camera lens can still move, but can only maintain the current magnification and cannot zoom.

Auto Tilt: Usually remains default. When “Auto Tilt” is turned off, the camera lens can only move horizontally.

Target Retention Time: can remain default. It is an important function to set how long it takes for the camera lens to return to the Home position or starting position after the tracking target is lost. The modification here takes effect immediately.

Step 3: Select the desired close-up effect.

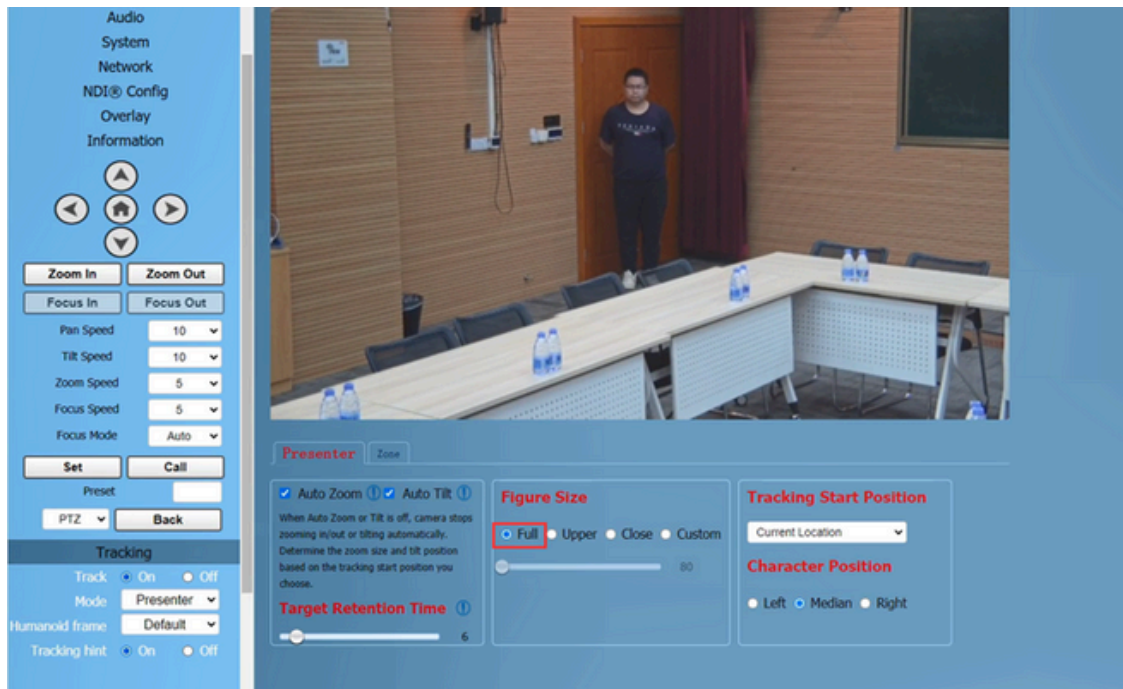

- **Figure Size**

By selecting different modes, users can customize the proportion of characters in the close-up screen, which is a very important feature. The modification here takes effect immediately.

Full: The close-up image includes tracking the entire body of the target, as shown in the figure above.

Upper: The close-up image includes tracking the target above the knee, as shown in the following figure.

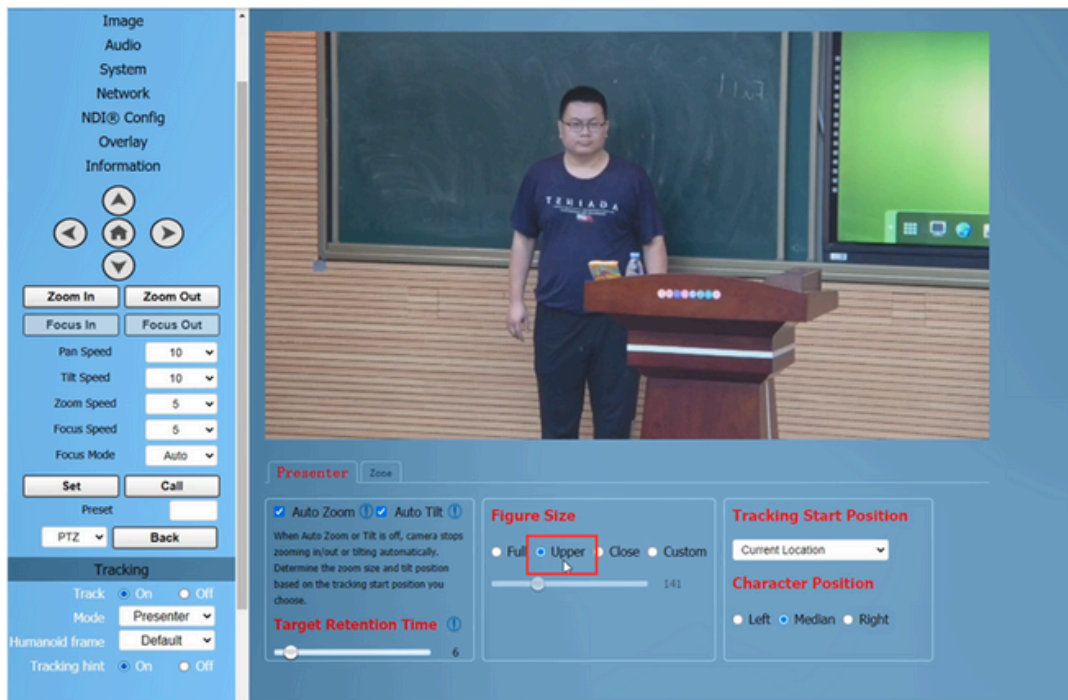

Close: The close-up image includes tracking the target above the waist, as shown in the following figure.

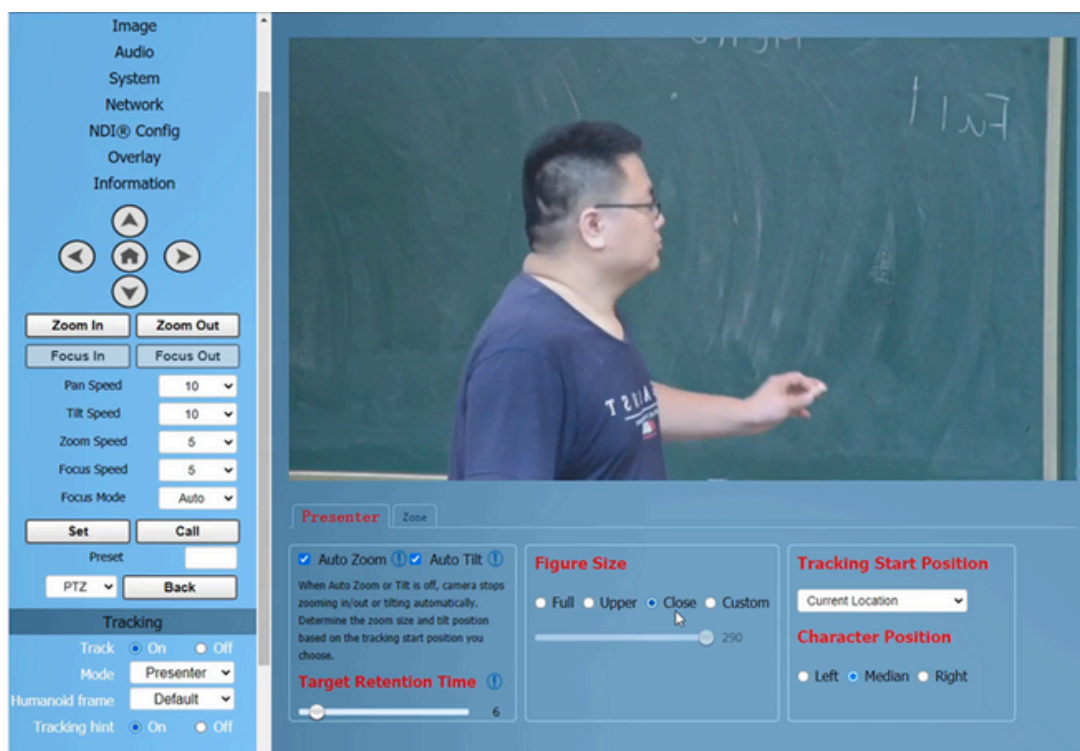

Custom: Adjust the tracking target proportion size.

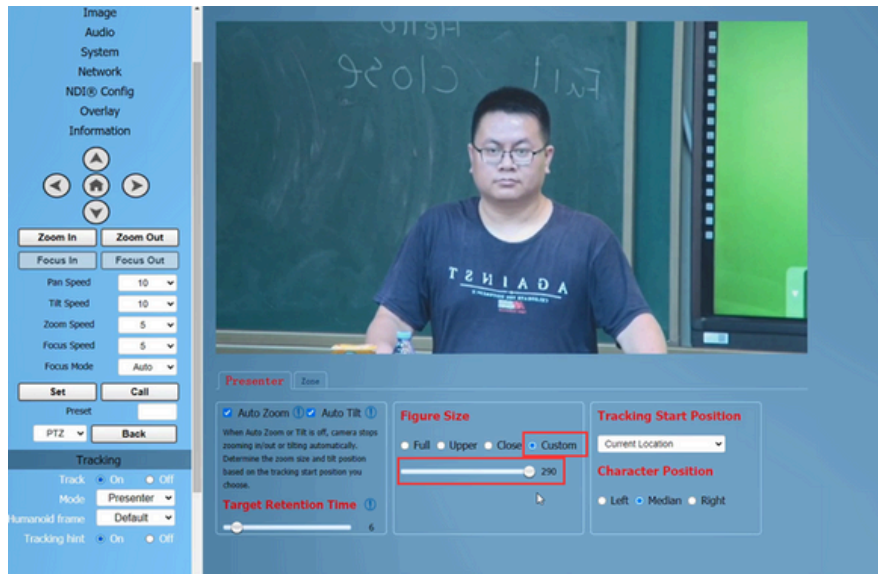

Note: If the proportion set is large, the proportion of the tracking target in the camera screen will also increase. When the tracking target moves rapidly, the camera may not keep up.

• **Tracking Start Position**

The user can choose the position of the camera lens when starting and stopping tracking.

Two Mode: Current Location/Preset 1

If you choose "Current Location", the camera position when tracking is turned on is the current position; Similarly, the camera position when stopping tracking will also stop at the current position.

If you choose "Preset 1", you need to set an additional preset position for the camera. When tracking is turned on, the camera will first move to Preset 1. If someone enters the video screen at this time, the camera will automatically track. When the tracking target is lost (exceeding the timeout), the camera will automatically move to Preset 1.



• **Character Position**

Character Position: defaults to median. Left or right can be selected by oneself, and this function is mostly used for live streaming scenes.

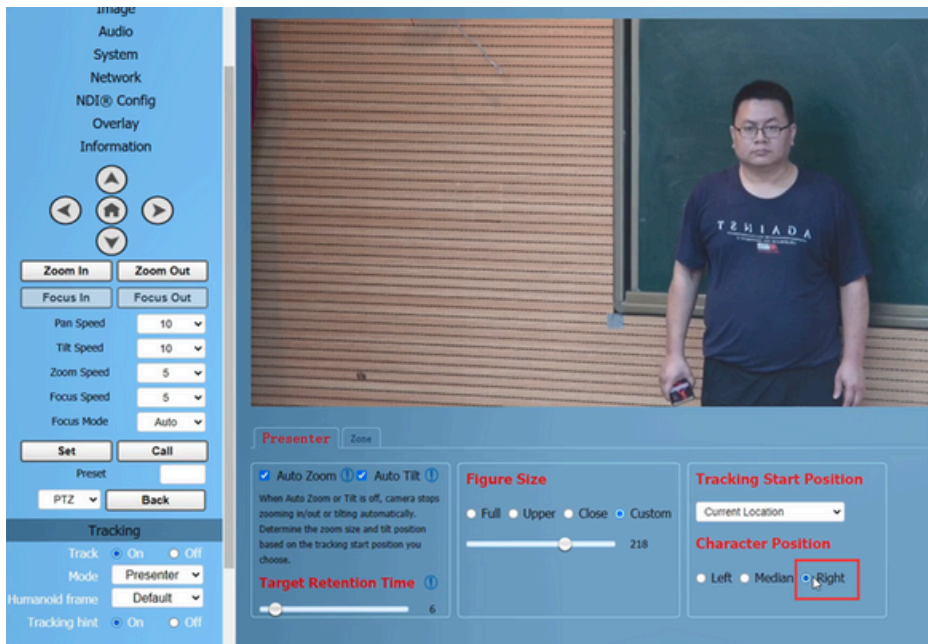
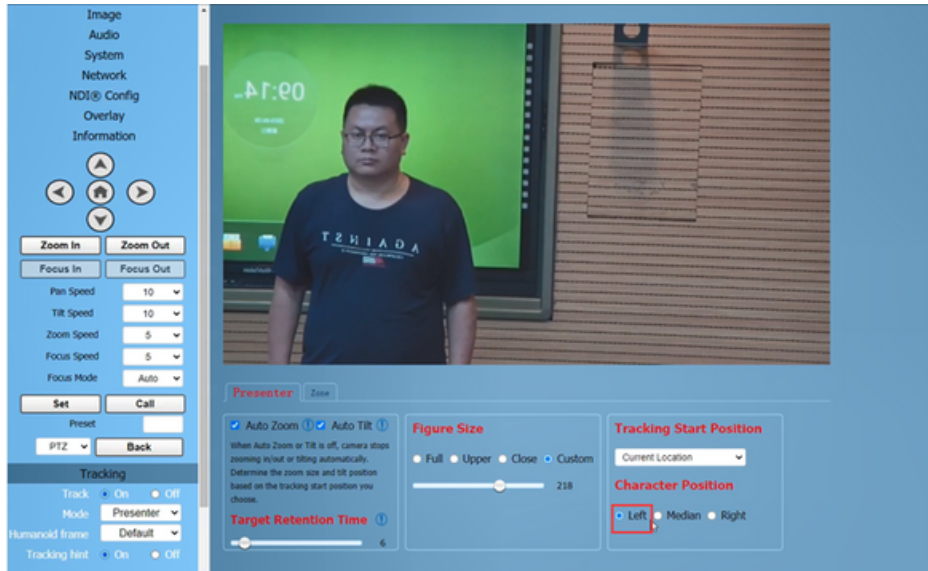

Step 4: According to the requirements of the application scenario, you can choose whether to require "Humanoid frame" and "Tracking hint", with default modes. Used in live streaming scenarios, it is often not opened for temporary adjustments during live streaming.

Humanoid frame: Default/Off/Debug

Default: After turning on tracking, if there are multiple people in front of the camera and pressing the direction key to select the tracking target, this box will automatically appear. After pressing the HOME key to confirm tracking, this box will disappear and the camera will start tracking.

Off: When selecting a tracking target, the humanoid box is not displayed at all. This feature is suitable for live streaming scenarios.

Debug: Turn on tracking, and the humanoid box will always appear on the tracking target. This feature is only applicable for debugging or demonstration.

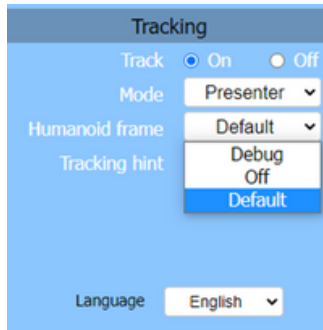

Tracking hint: On/Off

On: There will be a prompt in the upper left corner of the video during switch tracking.

Off: There is no prompt in the upper left corner of the video during switch tracking. This function is also applicable to live streaming scenarios.

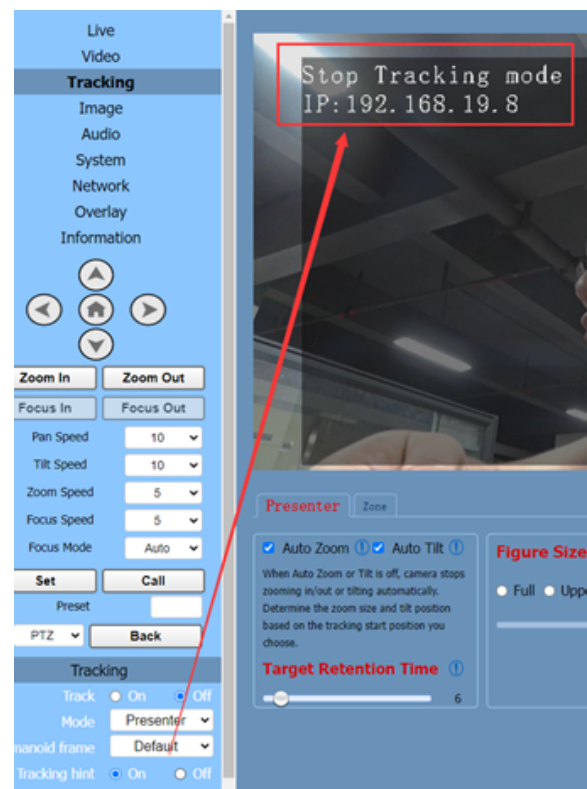
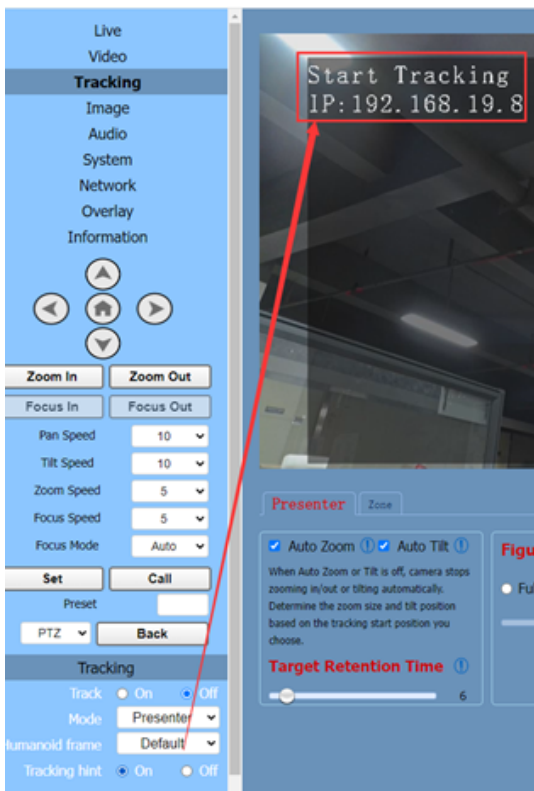

Step 5: Turn on tracking, press the arrow keys to select the tracking target, and then press Home to confirm.

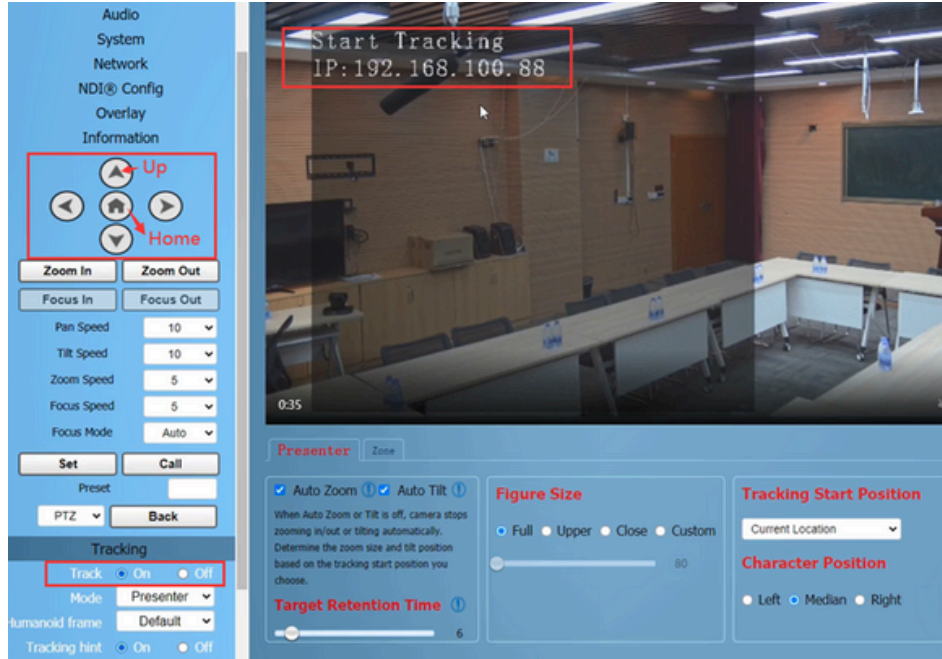

- **Area Tracking (Zone)**

Function: Divide the frequently active areas of the tracking target into several areas (A, B, C, D) as needed, and set corresponding preset positions and save them. When the tracking target enters this area, the camera will automatically call the preset position corresponding to the area to achieve tracking.

Step 1: Enter the "Tracking" page and select "Zone". In the track off state, set the tracking parameters.

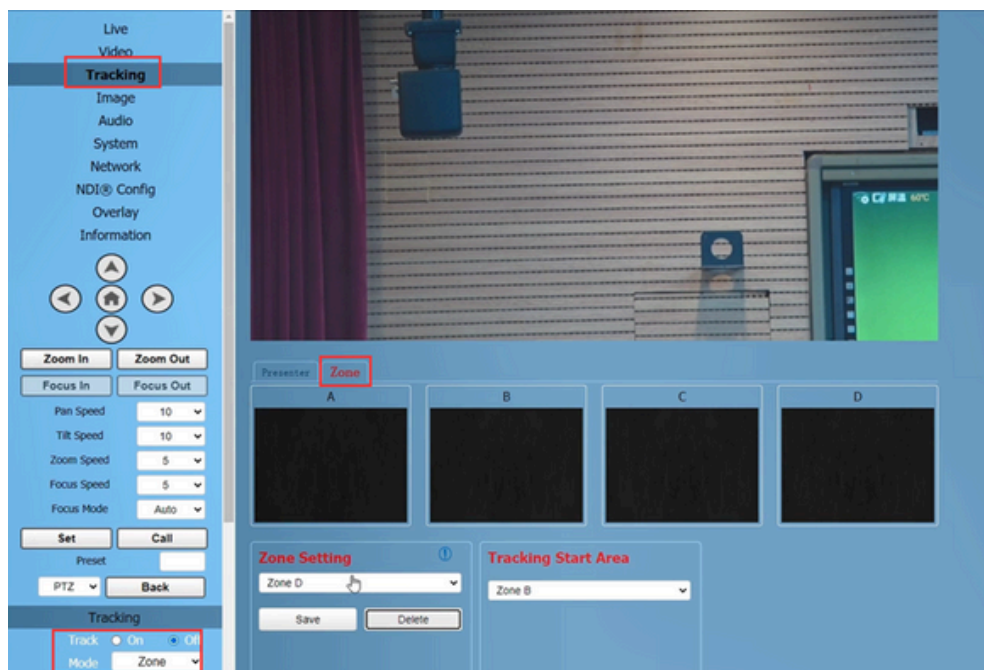

Step 2: Use the web interface's directional keys and Zoom In/Out to adjust the lens position, and set multiple preset positions such as Zone A successively and click "Save". The number of preset positions to be used in actual application scenarios can be considered by users themselves, but currently the maximum is 4. If the settings are incorrect, you can delete or reset them.

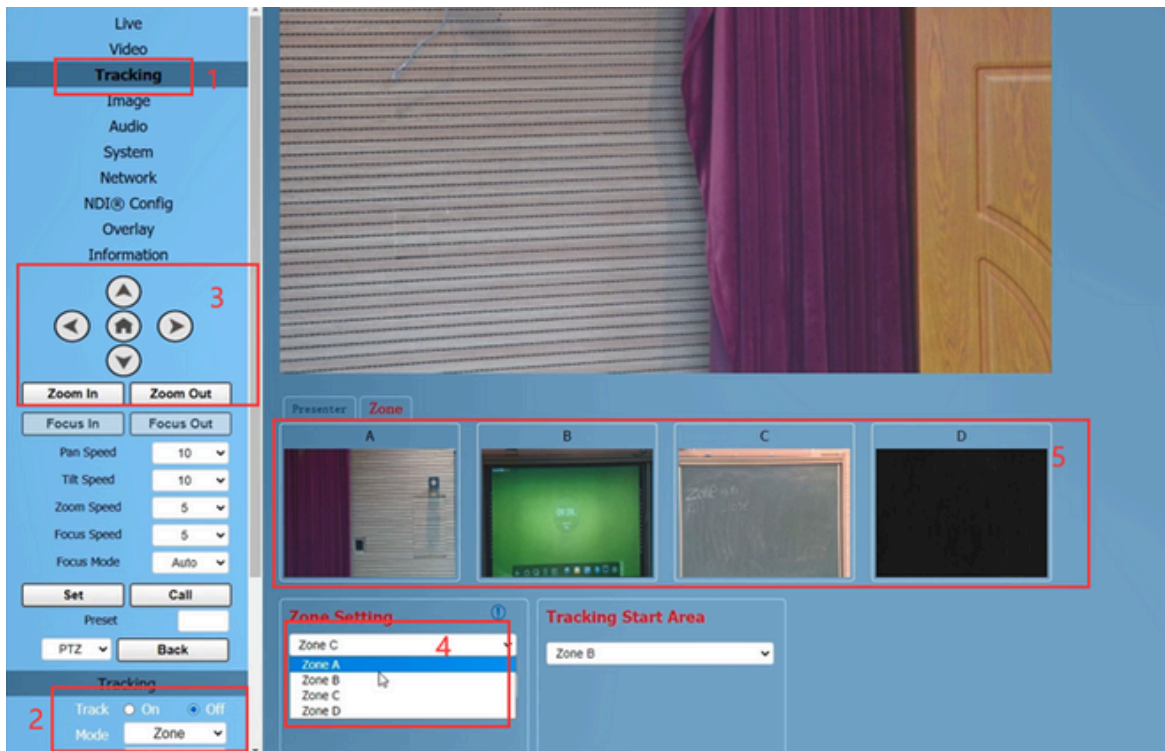
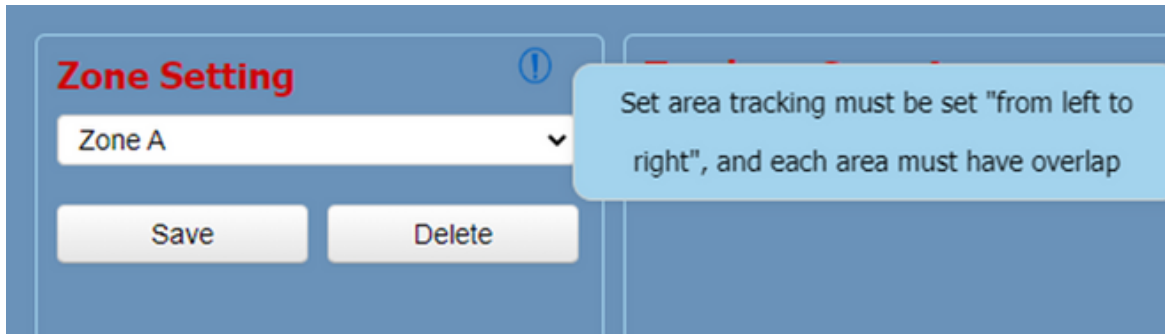

- **Tracking Start Area**

Tracking Start Area: You can select any Zone position as the tracking start or end position. When tracking is turned on, the camera will first move to this Zone position. If someone enters the video screen at this time, the camera will automatically track. When the tracking target is lost, the camera will automatically move to this Zone position.

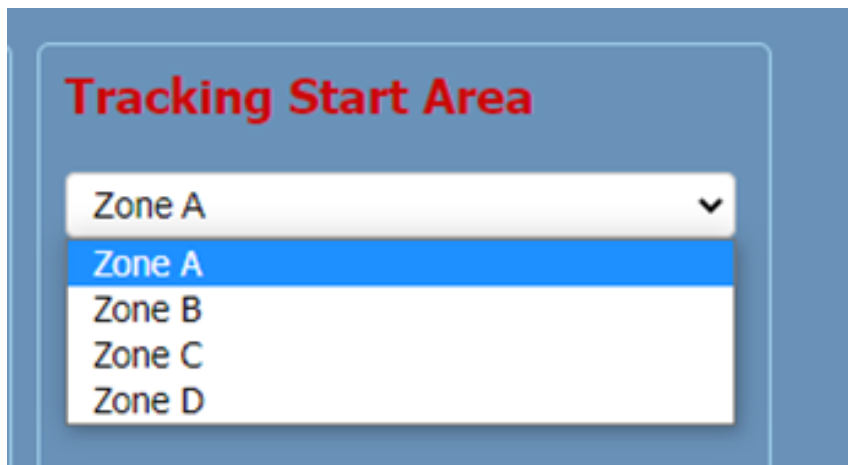
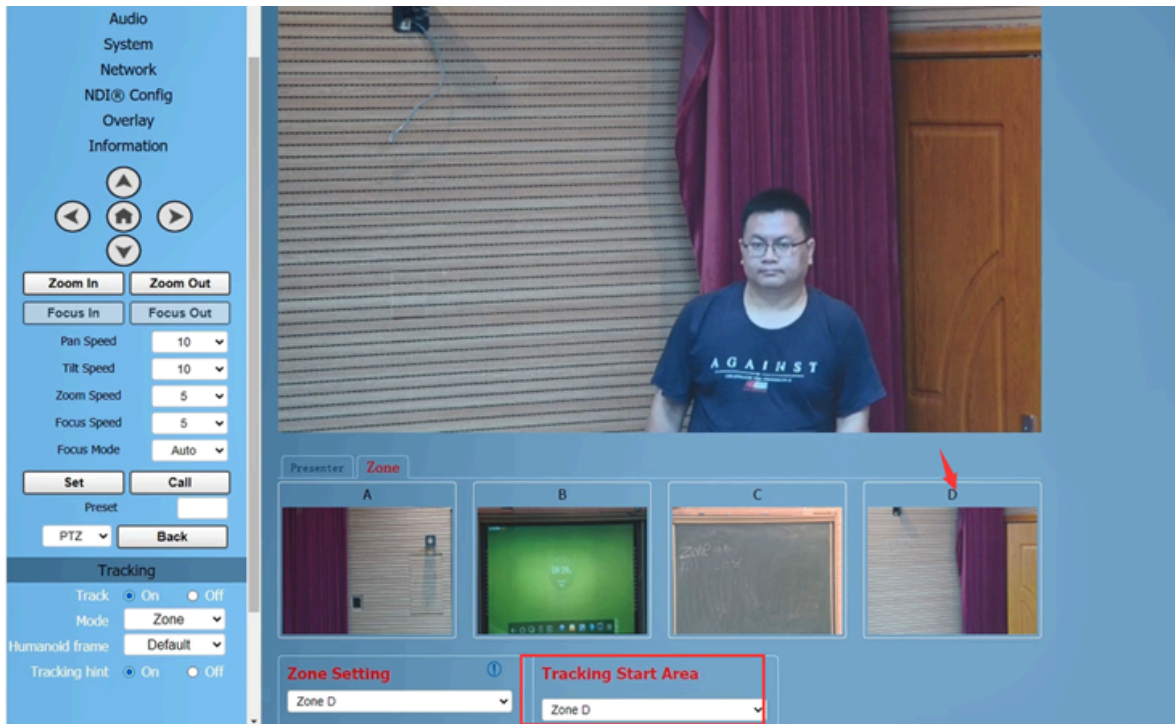

12.4 Image Settings

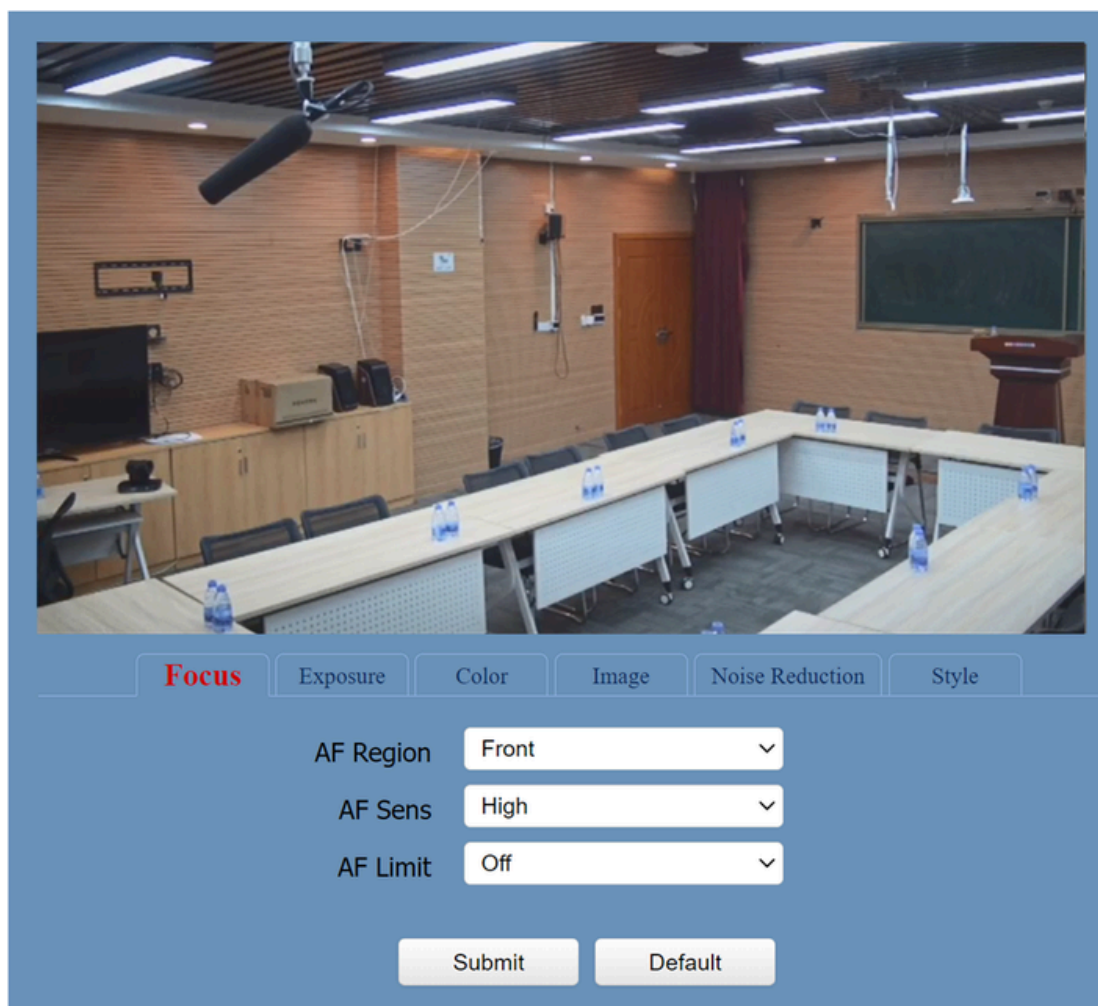

- 1) **Focus:** Focus of image: AF Region (Top, Center, Bottom, Front), AF Sens (High, Middle, Low), AF Limit (on, off)
- 2) **Exposure:** Exposure of image: Exposure Mode (Auto, Manual, SAE, AAE, Bright), Expcomp Mode (on, off), Backlight (on, off), Flicker Mode (off, 50Hz, 60Hz), Gain Limit (0~10), DRC Mode (Auto, off, Manual), DRC (0~14), Metering Mode (Average, Bottom, Center, Top)
- 3) **Color:** Color of image: WB Mode (Auto, Indoor, Outdoor, Manual, One Push, VAR), AWB Sens (Low, High, Middle), RG Tuning (-128~127), BG Tuning (-128~127), Saturation (60%~200%), Hue (0~99)
- 4) **Image:** Quality of image: Brightness (16~99), Contrast (16~99), Sharpness Mode (Auto, Manual), Gamma Mode (Auto, Manual), Gamma (0.45, 0.50, 0.54, 0.56, 0.63, Exp, HLG), Flip-H (on, off), Flip-V (on, off)
- 5) **Noise Reduction:** NR-2D Mode (Auto, Manual), NR-2D (0~99), NR-3D Mode (Auto, Manual)
- 6) **Style:** Style (Default, Cold, Warm, Clear, Soft, HLG, Education, User 1/2/3).

12.5 Audio Settings

Audio Settings

Audio Switch: On

Audio Type: AAC

Sample Rate: 48K

Bit Rate: 128K

Input Type: LINE IN

Input Vol L: 8

Input Vol R: 8

Submit Cancel

- 1) **Audio Switch:** Turn On/Off audio switch.
- 2) **Audio Type:** Optional items: AAC, G711A.
- 3) **Sample Rate:** Optional items: 32K, 48K, 16K.
- 4) **Bit Rate:** Optional items: 64K, 96K, 128K, 256K.
- 5) **Input Type:** Optional items: LINE IN, MIC.
- 6) **Input Vol L:** The volume of the left channel.
- 7) **Input Vol R:** The volume of the right channel.

12.6 System Settings

System Settings

Initialize User Online Upgrade

Reboot

Factory Default

- 1) **Initialize:** The user can perform a reboot or a factory default of the camera.
- 2) **User:** The user can modify the administrator and guest password (letters and Numbers only).
- 3) **Online Upgrade:** The user can update firmware version by selecting specific file.

12.7 Network Settings

1) **Lan Settings:** Default the IP address is 192.168.100.88, the MAC address cannot be modified.

2) **Port Settings:**

- HTTP Port: IP address identifies network device, the device can run multiple web applications, each network program using network port to transmit data, so data transmission to be carried out between the port and port. Port setting is to set up web server program using which port to transmit. When port mapping, need to be consistent with the port number (default port: 80).
- RTSP Port: The camera support RTSP protocol, use the VLC tools broadcast, default port: 554.
- TCP Port: Support TCP connection then control camera, default port: 5678.
- UDP Port: Support UDP protocol, default port: 1259.
- Sony Visca: Support Sony Visca, default value: 52381.

3) **RTMP(S) Settings:** Turn On/Off first stream or second stream, setting the MRL of RTMP.

4) **SRT Settings:** Turn On/Off SRT, Setting the SRT Port, SRT Encry and SRT Password.

5) **RTSP Settings:** Turn On/Off RTSP Auth.

6) **ONVIF Settings:** Turn On/Off ONVIF and ONVIF Auth.

7) **Multicast Settings:** Turn On/Off Multicast option, address 224.1.2.3, port 6688.

8) **NTP Settings:** Setting NTP Time Zone and Server Address. Turn On/Off Time Show, set the position of the Time Show. Turn On/Off Subtitle Display, set the Subtitle Content of the camera screen.

12.8 NDI® Settings (Optional)

NDI® Settings

Full NDI® On Off

NDI® Local Device Name

NDI® License

Key

NDI® Local Device Channel

NDI® Receive Group

Enable NDI® Discovery Server ▾

NDI® Discovery Server

Enable NDI® Multicast Server ▾

NDI® Multicast Address

NDI® Multicast Mask

NDI® Multicast TTL

NDI® Firmware Version

- 1) **NDI®|HB:** Turn On/Off NDI®|HB.
- 2) **NDI License:** Display NDI License verification results.
- 3) **Key:** Setting NDI® Key.
- 4) **NDI® Local Device Channel:** Enter the NDI Local Device Channel.
- 5) **NDI® Receive Group:** Enter the NDI Receive Group.
- 6) **Enable NDI® Discovery Server:** Turn On/Off NDI Discovery Server.
- 7) **NDI® Discovery Server:** Setting NDI Discovery Server address.
- 8) **Enable NDI® Multicast Server:** Turn On/Off NDI Multicast Server
- 9) **NDI® Multicast Address:** Setting NDI Multicast Address.
- 10) **NDI® Multicast Mask:** Setting NDI Multicast Mask.
- 11) **NDI® Multicast TTL:** Setting NDI® Multicast TTL.
- 12) **NDI® Firmware Version:** Display NDI® Firmware Version.

12.9 Overlay

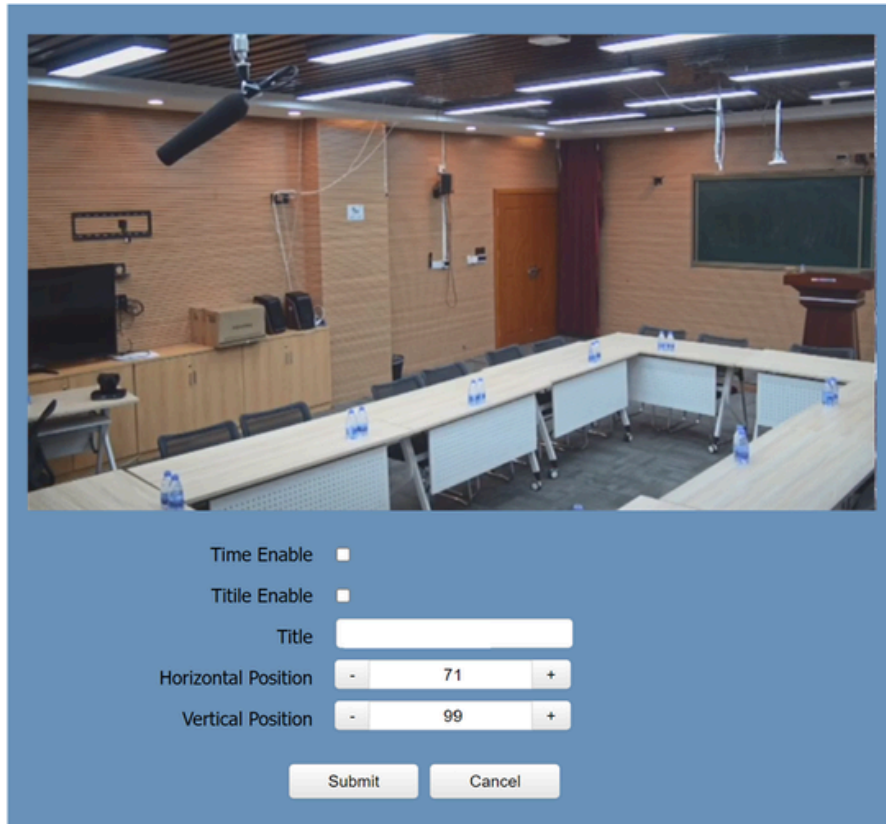

Time Enable

Titile Enable

Title

Horizontal Position - 71 +

Vertical Position - 99 +

Submit Cancel

- 1) **Time Enable:** Show or hide time
- 2) **Title Enable:** Show or hide title.
- 3) **Title:** Enter title.
- 4) **Horizontal Position:** Setting horizontal position.
- 5) **Vertical Position:** Setting vertical position.

12.10 Device Information

Information

Device ID

Device Type

Software Version

Webware Version

Device Serial Number

Submit Cancel

13. Troubleshooting

The monitor shows no image

- Check that the camera power supply is connected, the voltage is normal, and the power indicator light is always on.
- Turn off the power switch to check whether the camera is self-testing.
- Check the cable of video platform and TV whether correct connection.

The video image displayed by the camera lens is jittery

- Check whether the camera installed position be stabled.
- Check whether have vibrating machinery or object near the camera.

Unable to access camera through Browser

- Using PC to access the network to test whether the network access can work properly, first of all, the network fault caused by the PC virus can be eliminated, until the PC and camera can communicate with each other Ping.
- Disconnect the network, connect camera and PC separately, and reset the IP address of PC.
- Check IP address, subnet mask, and gateway settings for camera.
- Check whether the MAC address is conflicts.
- Check whether the web port is modified. The default web port is 80.

Forget the IP address or login password

Please remember (The default IP address: 192.168.100.88; default user name: admin; default password: admin).

Remote control cannot control

- Check and replace the new battery for the remote controller.
- Check whether the camera working mode is correct.
- Check whether the address of remote control can match the camera.

Serial port cannot control

- Check whether the camera protocol, address and baud rate such is the same.
- Check whether the control line is connected well.

