

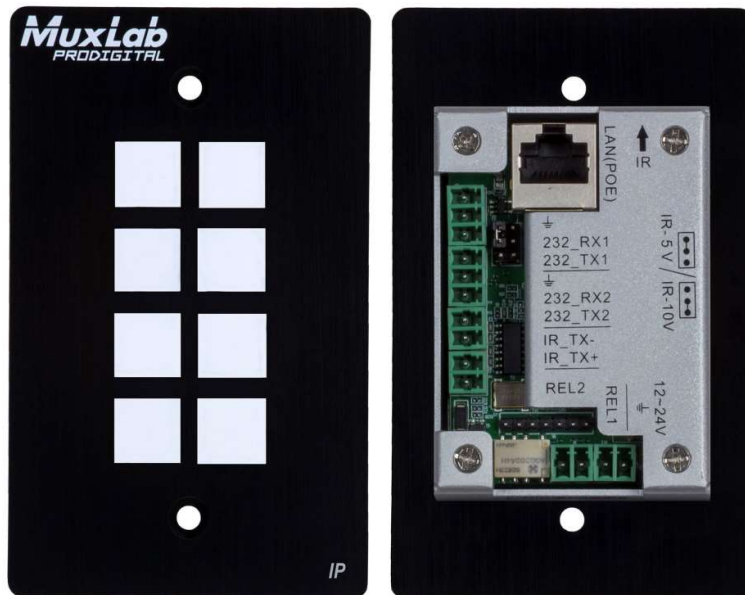

8 Button IP PoE Control Panel Installation and Operation Manual 500816-IP



Introduction

The 8 Button IP PoE Control Panel (Model: 500816-IP) is a versatile wall or table-top mounted control panel for MuxLab AV over IP devices, select Matrix Switches, and third party products. Each button is programmable. The unit supports one (1) Ethernet port (for TCP/IP and Telnet), two (2) RS-232 ports, one (1) Infrared port, and two (2) Relay ports, for control of end devices. The 8 Button IP PoE Control Panel can control MuxLab products including MuxLab's AV over IP system via the 500811 ProDigital Network Controller, MuxLab's TCP/IP, Telnet and RS-232 managed Matrix Switches, as well as third party devices such as projectors and projector screens, displays, AV sources and other similar devices.

The 500816-IP supports a web interface, allowing it to be configured and managed via a browser. The web interface allows the unit keys to be programmed individually, supports IR learning and unit configuration.

Panel Description

Front panel view:

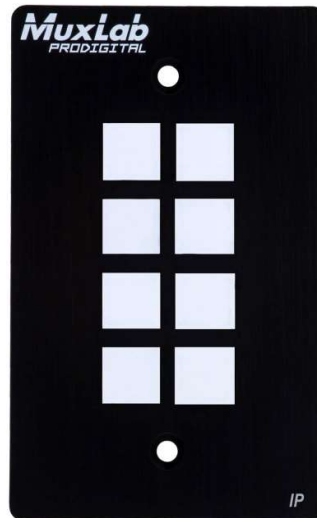

All buttons can be programmed to control each TCP/IP, Telnet, RS-232, IR, and Relay controllable end device. Each key supports a removable clear plastic cover, allowing a label to be inserted to reflect the programming of each button.

Rear panel view:

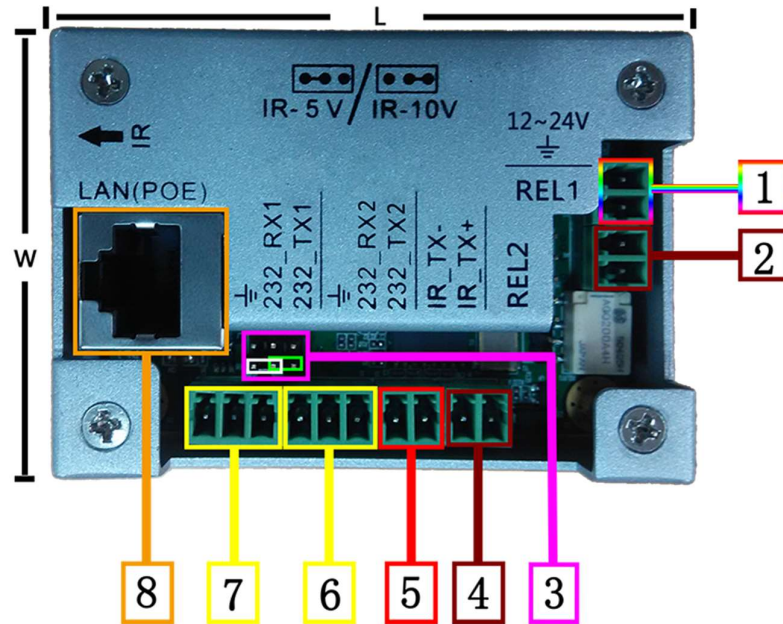

1. Power: DC Power Input supporting 12-24VDC (12VDC@1A is recommended)
2. Relay #1: An electrically operated switch
3. IR output power jumper: jumper left 2 pins for 5V, or right 2 pins for 10V.
4. Relay #2: An electrically operated switch
5. IR: Infrared radiation digital data output
6. Rs232 #2: RS-232 data output
7. Rs232 #1: RS-232 data output
8. LAN (PoE): LAN port with PoE (PD) power for web interface control

Top panel view:

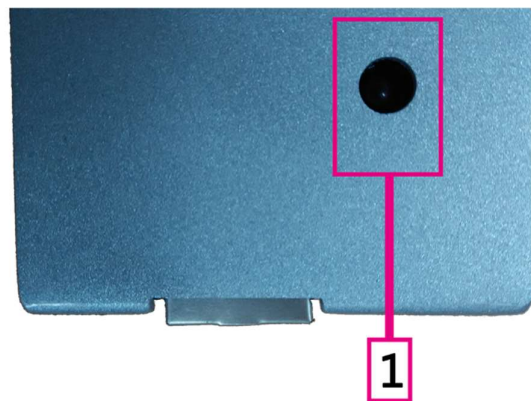

1. IR reader: Learning IR sensor, supporting a frequency of 38KHz

Configuration: Unit Initialization

Before initial use, the user must initialize (factory reset) the 500816-IP configuration. To initialize the unit, press and hold the first, third and fifth key as indicated below. Continue to hold these keys while the unit goes through the following illuminated key color sequence, including the lights of these three buttons will turn off, then each of the eight buttons will illuminate (turn on) in red one by one until all are lit, and then they will all flash in green to end the sequence. This sequence is shown below. Note that this restores the factory default settings.

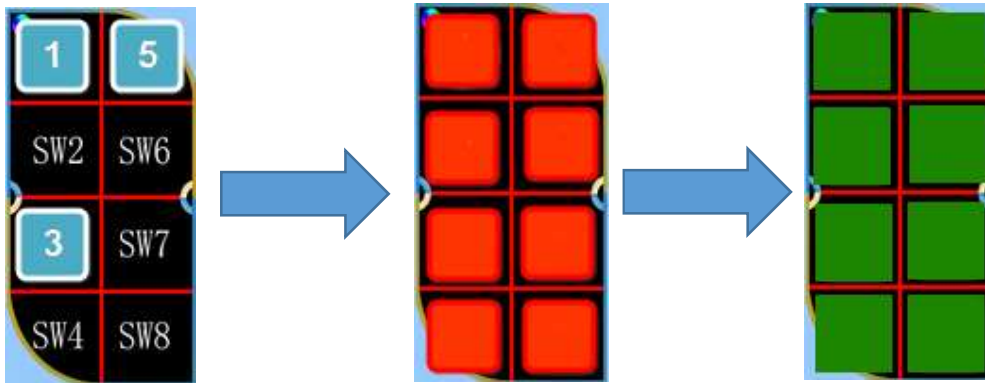

Web Server

The units comes with a factory default IP Address of: 192.168.168.54

To access the unit web server, the user can directly connect a PC LAN port to the 500816-IP LAN port with a straight polarity Ethernet cable. After connecting the PC and 8 Button IP PoE Control Panel, go to the PC network connection section to change the PC's IP property status to "Static IP" and set the PC IP address to say 192.168.168.178, Subnet Mask to 255.255.255.0 and Default Gateway to 192.168.168.1, as shown below. Once done, open a web browser and enter the IP Address 192.168.168.54 to access to the 500816-IP web server.

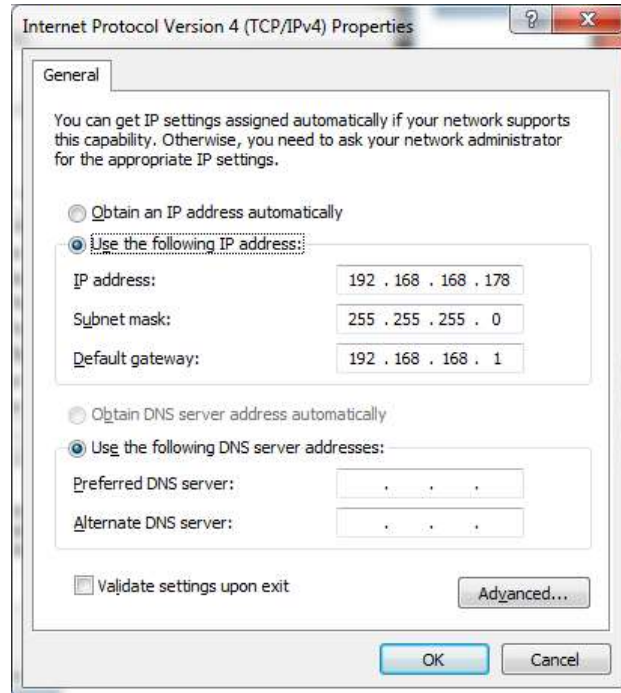

The user must now set the 8 Button IP PoE Control Panel to the same IP segment as the local area network where the device will be used. To accomplish this go to the Network section via the 500816-IP web interface, see below, and set the 8 Button IP PoE Control Panel IP address accordingly to match the local area network IP Address setting.

For example if the LAN IP segment is set as 192.168.88.xxx, then set the product IP Address to 192.168.88.1xx. Once the IP Address is set, then the user can access this device in the intended local area network via the 500816-IP web interface using the IP Address 192.168.88.1xx (where xx represents the settings selected above).

User Login

User ID

Password

The factory default:
 IP: 192.168.168.54
 User ID: admin
 Password: admin

After accessing the 8 Button IP PoE Control Panel web server, the default user ID is **admin**, and the password is **admin**. Login to configure and manage the unit.

Setting Menu

After login, go to the **Setting** Menu to manage LAN, RS-232, IR parameters, User ID and Password, and Button rename.

IR Learning:

Please go to the IR Event chapters for further details.

Lan Control / Net Control:

Users can set DHCP, IP Address, Subnet Mask, Default Gateway, TCP/IP Server, plus Client and Host IP TCP Port info in the Net Control sub-section, see below.

Lan Control / Version Information:

Note that System hardware, boot loader and software version information is listed in the Version information sub-section, see below.

Keypad	Net Control
	Use DHCP: <input type="radio"/> On <input checked="" type="radio"/> Off
	IP Address: <input type="text" value="192.168.168.54"/>
	Net Mask: <input type="text" value="255.255.255.0"/>
	Gateway: <input type="text" value="192.168.168.1"/>
	TCP Protocol: <input checked="" type="radio"/> Server <input type="radio"/> Client
	Host IP: <input type="text" value="192.168.168.67"/>
	TCP Port: <input type="text" value="1001"/>
	<input type="button" value="Apply"/>
	Product Information
Product Name: <input type="text" value="8-Button IP PoE Control Panel"/>	
Model Name: <input type="text" value="800818-IP"/>	
Custom Name: <input type="text"/> <input type="button" value="Apply"/>	
Version Information	
System Software: <input type="text" value="V2.1"/>	
System Hardware: <input type="text" value="V1.0"/>	
Bootloader Software: <input type="text" value="V2.0"/>	

Rs232 Set:

The User can set Rs232_1 and Rs232_2 Baud Rate, Data Bits, Stop bit and Parity settings. The factory default is as shown below.

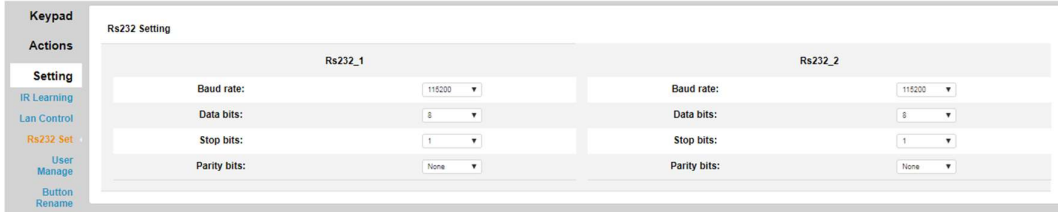

Keypad Menu

Under the Keypad Menu, the user can click on a virtual keypad to toggle real button functions from within the web interface page. This can be used to test the button programming or to active a button remotely.



Actions Menu

The Actions Menu is where the user programs the button functions. There are 8 buttons to program, where each button supports 2 Modes, 6 Actions, a timer control between each Action, and 11 Events (selection of each Action).

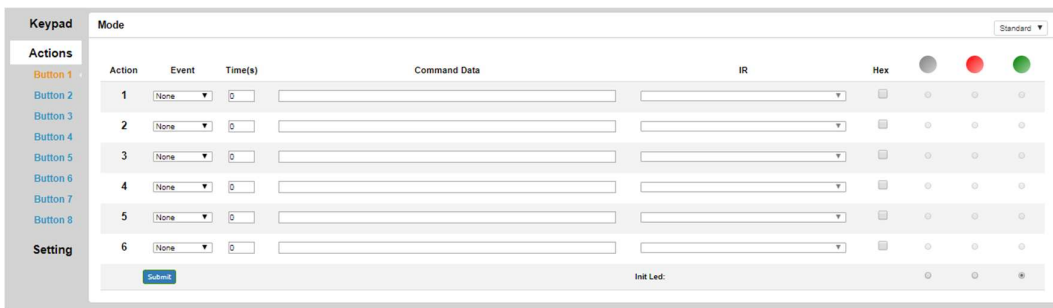

Mode Selection

The 8 Button IP PoE Control Panel buttons support Standard and Toggle Mode functions. When a button is in Standard Mode, each button press executes the same action. However Toggle Mode supports 2 different actions on the same button, which can be executed alternately with each button press. This is referred to here-in as Release and Latch. The user can also set an Led color (options are off “no color”, red and green) to identify the working mode or command being sent. Toggle Mode is often used as a Turn On and Turn Off function.

Action	Event	Time(s)	Command Data	IR	Hex	Initial Led
1	None	0				Off
2	None	0				Off
3	None	0				Off
4	None	0				Off
5	None	0				Off
6	None	0				Off

Standard Mode

Action	Event	Time(s)	Command Data	IR	Hex	Initial Led
1	None	0				Off
2	None	0				Off
3	None	0				Off
4	None	0				Off
5	None	0				Off
6	None	0				Off

Toggle Mode

Event Selection

Note: The information here is based on the Standard Mode, but Toggle Mode is supported in the same manner.

The 500816-IP supports 11 events as shown below:

Event

None ▾

None

IR

IP_Send

IP_Ack

Led

Relay1_NO

Relay2_NO

Rs232_1

Rs232_2

Rs232_1Ack

Rs232_2Ack

None: Do nothing

IR: Sent out IR code

IP_Send: Sent data to TCP Server by LAN

IP_Ack: Get data from TCP Client by LAN

Led: Led color control

Relay1_NO: Trigger Relay1

Relay2_NO: Trigger Relay2

Rs232_1: Sent data to RS-232 Port 1

Rs232_2: Sent data to RS-232 Port 2

Rs232_1Ack: Get data From RS-232 Port 1

Rs232_2Ack: Get data from RS-232 Port 2

None Event:

Both in Standard and Toggle Mode, the “None” event does nothing, and will clear the Command Data

Mode Standard ▾

Action	Event	Time(s)	Command Data	IR	Hex
1	None ▾	0	<input type="text"/>	<input type="text"/>	<input type="checkbox"/> <input type="checkbox"/> <input type="checkbox"/> <input type="checkbox"/>

Mode Toggle ▾

Latch ▾

Action	Event	Time(s)	Command Data	IR	Hex
1	None ▾	0	<input type="text"/>	<input type="text"/>	<input type="checkbox"/> <input type="checkbox"/> <input type="checkbox"/> <input type="checkbox"/>

IR Event:

The User should learned IR codes before using the IR code send function. Go to “Setting \ IR Learning” menu for more details.

How to perform IR Learning:

The system can store 10 IR codes.

1. Input the name of the IR code (use underscore to replace a “space bar”)
2. Click IR Learning
3. Click Save, “INFRARED MODULE IS LEARNING....” will be displayed on the State Frame
4. Present an IR signal to the IR receiver port within 30 seconds
5. “INFRARED MODULE STUDY COMPLETED” will be displayed indicating that learning is finish
6. If the IR receiver did not get an IR signal input within 30 seconds, it will close the learning action and display “learning over time....”, meaning learning time expired

Input the IR Name, click Learning box, and click Save:

IR Learning							
N	Label	State	Learning	N	Label	State	Learning
1	IR_text_1	INFRARED MODULE IS LEARNING	<input checked="" type="checkbox"/>	6			<input type="checkbox"/>
2			<input type="checkbox"/>	7			<input type="checkbox"/>
3			<input type="checkbox"/>	8			<input type="checkbox"/>
4			<input type="checkbox"/>	9			<input type="checkbox"/>
5			<input type="checkbox"/>	10			<input type="checkbox"/>

Learning timeout message:

IR Learning							
N	Label	State	Learning	N	Label	State	Learning
1	IR_text_1	Learning over time	<input checked="" type="checkbox"/>	6			<input type="checkbox"/>
2			<input type="checkbox"/>	7			<input type="checkbox"/>
3			<input type="checkbox"/>	8			<input type="checkbox"/>
4			<input type="checkbox"/>	9			<input type="checkbox"/>
5			<input type="checkbox"/>	10			<input type="checkbox"/>

Connect the IR transmitter to the system and select the IR code in the IR pull-down menu and click the Submit button.

Example of IR command from pull-down menu:

Action	Event	Time(s)	Command Data	IR	Hex
1	IR	0		IR_text_1	<input type="checkbox"/> <input type="checkbox"/> <input type="checkbox"/> <input type="checkbox"/>
2	None	0			<input type="checkbox"/> <input type="checkbox"/> <input type="checkbox"/> <input type="checkbox"/>
3	None	0			<input type="checkbox"/> <input type="checkbox"/> <input type="checkbox"/> <input type="checkbox"/>
4	None	0			<input type="checkbox"/> <input type="checkbox"/> <input type="checkbox"/> <input type="checkbox"/>
5	None	0			<input type="checkbox"/> <input type="checkbox"/> <input type="checkbox"/> <input type="checkbox"/>
6	None	0			<input type="checkbox"/> <input type="checkbox"/> <input type="checkbox"/> <input type="checkbox"/>

Submit Init Led:

The user can also input the IR code directly into the Command Data area, if known.

Example of IR command entered directly:

Action	Event	Time(s)	Command Data	IR	Hex
1	IR	0	0891683108705500F011000D9168311		<input type="checkbox"/> <input type="checkbox"/> <input type="checkbox"/> <input type="checkbox"/>

IP_Send Event:

The IP Send Event can send a TCP/IP command or a Telnet command.

Sending a TCP/IP Command:

The IP Send Event can send ASCII or HEX character commands to a given IP address.

TCP/IP Format: IP address*Port*TCP*Data

Example:

To send: 123456789 to IP Address 192.168.168.51

The format is: 192.168.168.51*1001*TCP*123456789, ASCII (but do not click on the Hex box), see below.

Action	Event	Time(s)	Command Data	IR	Hex
1	IP_Send	0	192.168.168.51*1001*TCP*123456789		<input type="checkbox"/> <input type="checkbox"/> <input type="checkbox"/> <input type="checkbox"/>

Sending a Telnet Command:

The IP Send Event can send ASCII or HEX character commands to a given IP address.

Telnet Format: IP address*Port*Telnet*Data*Login ID*Login Password, where "Login ID" and "Login Password" are optional and should only be used if required by

the equipment being controlled. It can take several seconds for a command to be sent (between 1 to 9 sec), depending on the time taken to log in to the telnet session.

Example:

To send: 123456789 to IP Address 192.168.168.51

The format is: 192.168.168.51*23*Telnet*123456789, ASCII (but do not click on the Hex box), see below. In this example “Login ID” and “Login Password” were not used.

Mode							Standard		
Action	Event	Time(s)	Command Data	IR	Hex	<input type="radio"/>	<input type="radio"/>	<input type="radio"/>	
1	IP_Send	0	192.168.168.51*23*Telnet*123456789		<input type="checkbox"/>	<input type="radio"/>	<input type="radio"/>	<input type="radio"/>	

IP_Ack Event:

The IP Ack Event is used by the 8 Button IP PoE Control Panel to get feedback from the device being controlled via IP commands, and is used to compare the feedback with predefined data in order to decide whether to continue or stop a given action. If the 500816-IP did not get any feedback, it will auto resend data up to 5 more times. If there are many IP_Send events in the system, the IP address and port of the IP_Ack event will relate to the previously sent IP_Send event. Therefore make sure there is a IP_Send event before each IP_Ack event. Note: The IP_Ack is only valid for the TCP/IP command not the Telnet command.

Mode							Standard		
Action	Event	Time(s)	Command Data	IR	Hex	<input type="radio"/>	<input type="radio"/>	<input type="radio"/>	
1	IP_Send	0	192.168.168.51*1001*123456789		<input type="checkbox"/>	<input type="radio"/>	<input type="radio"/>	<input type="radio"/>	
2	IP_Ack	0	helloworld		<input type="checkbox"/>	<input type="radio"/>	<input type="radio"/>	<input type="radio"/>	

IP Button Trigger Command: >BtnX<cr>

The IP command is a command that allows many 8 Button IP PoE Control Panels to work together. It can trigger another 8 Button IP PoE Control Panel unit to execute a button event.

Command: >BtnX<cr>

Where X represents the button number from 1 to 8, and <cr> is HEX 0D

For Example: Send IP command “>Btn3<cr>” to another 500816-IP unit with IP address: 192.168.168.100, in order to trigger IP address 192.168.168.100, Port 1001 of that 500816-IP controller Button 3 event.

1. Select IP_Send event
2. Input 192.168.168.100*1001* 3E 42 74 6E 33 0D , in the Command Data area and click the Hex box (since 3E 42 74 6E 33 0D is the Hex code for: >Btn3<cr>)
3. Click the Submit Button

The IP_Send event, IP_Ack event, and IP Button Trigger Command are the main commands typically used for IP control. The user can build up flexible IP control applications by making efficient use of them.

LED Event:

LED Event allows the user to setting/change the button LED color. The system supports LED off, LED color Green and LED color Red options. The user can select an LED Event and then select the input button number (within the Command Data area), and then select the LED event color on the far right side.

Action	Event	Time(s)	Command Data	IR	Hex
1	Led	0	12345678		<input checked="" type="radio"/> <input type="radio"/> <input type="radio"/>

Relay1_NO/Relay2_NO Event:

The 8 Button IP PoE Control Panel relay port may be connected to a DC power supply or voltage source of up to 24VDC, and to a device which the user wishes to control via this voltage (or to another relay to control higher voltage systems). The contact relay of the 500816-IP is normally open (NO). Select event Relay (such as Relay1_NO) and press Submit, as shown below.

Once the command is sent (submitted), the Relay is then closed until it is pressed again, where it will reopen. This function works as a toggle switch (regardless on the mode setting), such that each time the command is sent via the assigned button the relay state changes from open to close or close to open. This is true even for "Standard" mode.



RS232_1/RS232_2 Event:

The user can choose either the Rs232_1 or Rs232_2 port to send RS-232 data. The factory RS-232 setting is: Baud rate 115200, Data bits 8, Stop bits 1, and no-Parity bits.

Standard Mode:

Select Standard Mode from the pull-down box. When pressing a button in this mode, the 500816-IP controller will send the command data through the RS-232 port as shown below.

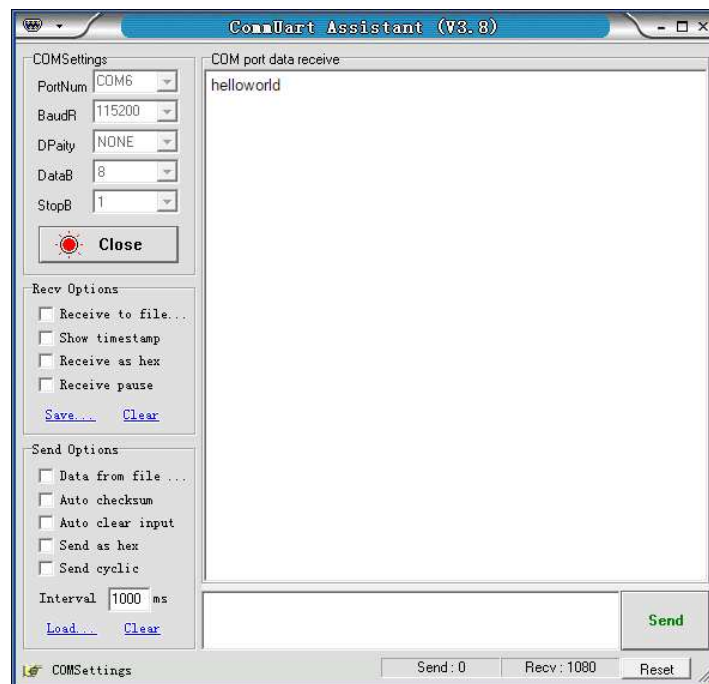
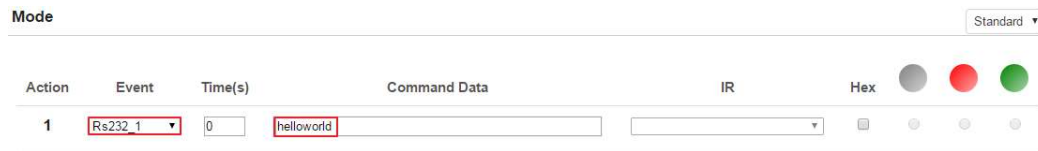

Hex: By pressing the Hex selection box, the user can type Hex data in the Command Data field of the 500816-IP Controller, which will then send this Hex data out through the 500816-IP RS-232 port.

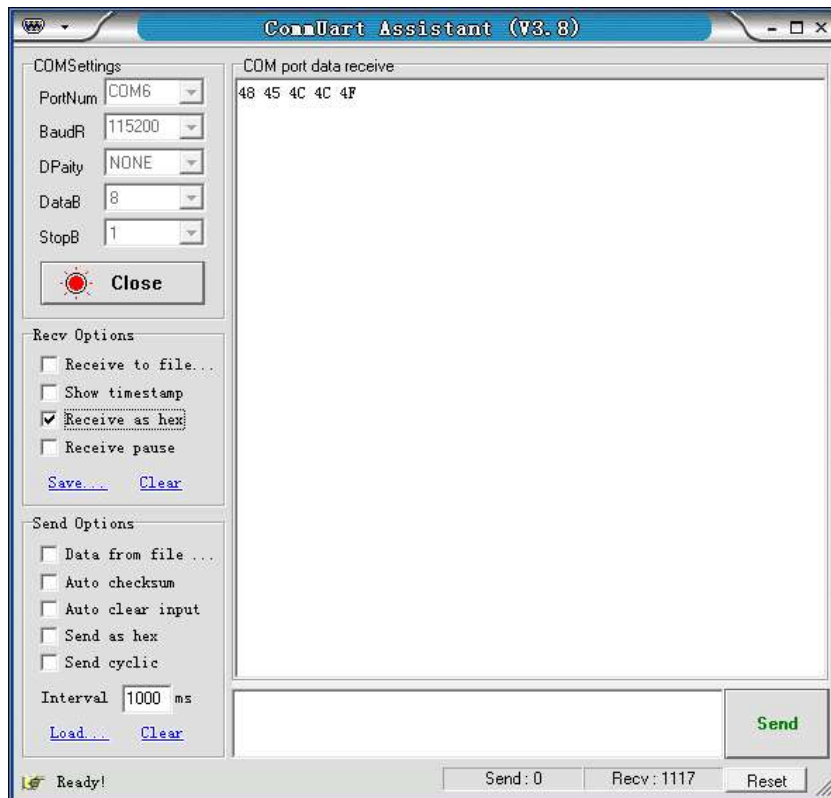
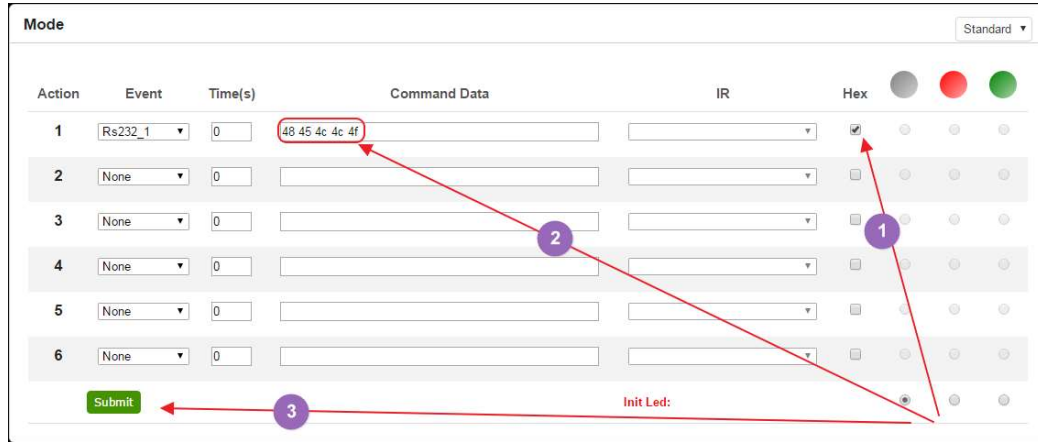

Note: Same operations support Toggle Mode, but Toggle Modes must be selected as shown below.

The screenshot shows a configuration window with a 'Mode' dropdown set to 'Latch' and a 'Toggle' button. Below is a table with two rows:

Action	Event	Time(s)	Command Data	IR	Hex
1	Rs232_1	0	helloworld		<input type="checkbox"/> <input type="checkbox"/> <input type="checkbox"/> <input type="checkbox"/>
2	Rs232_2	0	helloworld		<input type="checkbox"/> <input type="checkbox"/> <input type="checkbox"/> <input type="checkbox"/>

Rs232_1Ack and Rs232_2Ack Event:

Rs232_1Ack and Rs232_2Ack Events are used to allow the 500816-IP controller to get feedback from RS-232 devices, and to compare the feedback string with predefined data to decide whether or not the action (operation) should continue or be stopped. If the controller did not receive any feedback, it will auto resend the data up to 5 times. Make sure that there is an Rs232 event before an Rs232_Ack event.

The screenshot shows a configuration window with a 'Mode' dropdown set to 'Standard'. Below is a table with six rows:

Action	Event	Time(s)	Command Data	IR	Hex
1	Rs232_1	0	123456789		<input type="checkbox"/> <input type="checkbox"/> <input type="checkbox"/> <input type="checkbox"/>
2	Rs232_1Ack	0	helloworld		<input type="checkbox"/> <input type="checkbox"/> <input type="checkbox"/> <input type="checkbox"/>
3	None	0			<input type="checkbox"/> <input type="checkbox"/> <input type="checkbox"/> <input type="checkbox"/>
4	None	0			<input type="checkbox"/> <input type="checkbox"/> <input type="checkbox"/> <input type="checkbox"/>
5	None	0			<input type="checkbox"/> <input type="checkbox"/> <input type="checkbox"/> <input type="checkbox"/>
6	None	0			<input type="checkbox"/> <input type="checkbox"/> <input type="checkbox"/> <input type="checkbox"/>

At the bottom left is a green 'Submit' button. At the bottom right is a red 'Init Led:' label and three status indicators (grey, red, green).

IP pass through RS-232 Command:

The IP pass through RS-232 command allows users to send data from IP to RS-232 or vis-versa. This means that the 500816-IP controller can function as a control repeater.

>CSNumTXMsg<CR>

Where "Num" can be: "0" for LAN, "1" for Rs232 port 1, and "2" for Rs232 port 2

"Msg" is: The pass through Data

and <CR> is 0D in HEX

For Example: to send "Hello" from RS232 to LAN, the Hex code is:

```
3E 43 53 30 54 58 48 65 6C 6C 6F 0D
```

>CS0TXHello<CR>

```
>CS0TXHello
```

For Example: to send "world" from LAN to RS-232 port 1, the Hex code is:

```
3E 43 53 31 54 58 77 6F 72 6C 64 0D
```

>CS1TXworld<CR>

```
>CS1TXworld
```

Time(S) Application:

Each button can execute up to 6 events. A time delay between each event can be set. Time(S) is the time delay set between 2 events (in seconds), see below.

Mode											
Action	Event	Time(s)	Command Data	IR	Hex	<input type="checkbox"/>	<input type="checkbox"/>	<input type="checkbox"/>	<input type="checkbox"/>	<input type="checkbox"/>	<input type="checkbox"/>
1	Rs232_1	5	Hello World			<input type="checkbox"/>	<input type="checkbox"/>	<input type="checkbox"/>	<input type="checkbox"/>	<input type="checkbox"/>	<input type="checkbox"/>
2	Led	5	123456			<input type="checkbox"/>	<input type="checkbox"/>	<input type="checkbox"/>	<input type="checkbox"/>	<input checked="" type="checkbox"/>	<input type="checkbox"/>
3	Relay1_NO	5				<input type="checkbox"/>	<input type="checkbox"/>	<input type="checkbox"/>	<input type="checkbox"/>	<input type="checkbox"/>	<input type="checkbox"/>
4	Relay2_NO	5				<input type="checkbox"/>	<input type="checkbox"/>	<input type="checkbox"/>	<input type="checkbox"/>	<input type="checkbox"/>	<input type="checkbox"/>
5	IP_Send	5	192.168.168.51*1001*IP_Send			<input type="checkbox"/>	<input type="checkbox"/>	<input type="checkbox"/>	<input type="checkbox"/>	<input type="checkbox"/>	<input type="checkbox"/>
6	Led	5	123456			<input type="checkbox"/>	<input checked="" type="checkbox"/>	<input type="checkbox"/>	<input type="checkbox"/>	<input type="checkbox"/>	<input type="checkbox"/>

Init Led:

Update Firmware

Connect the 500816-IP Controller to a PC with a network cable.

Press and hold the first and the last button (button 1 and 8) on the 500816-IP, and while hold these buttons pressed connect the power supply (with power) to the 500816-IP. The 500816-IP Controller will enter boot loader mode and each LED will flash green starting from the first to the last button.



Open the Boot Loader software available on the MuxLab website under the 500816-IP webpage or under the Support → Software/Firmware section, and type the IP address and TCP Port of the 500816-IP Controller (default is: IP Address 192.168.168.54 and port 1001), as shown below.

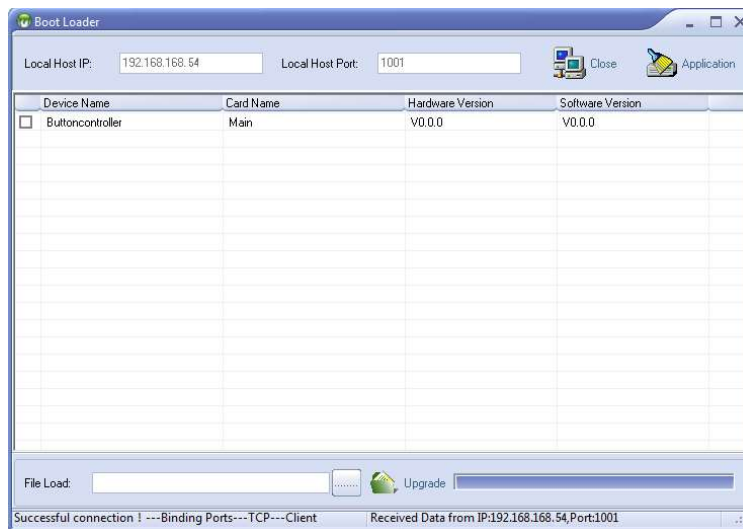

Click the 500816-IP Controller and select the new firmware file to upload, and then click Upgrade. Please wait for the upgrade process to complete.

To finalize the upgrade process, restore factory settings by holding the first, third and fifth button at the same time, and the Upgrade will succeed.

Safety Information



To reduce the risk of electric shock, do not expose this product to rain or moisture



Do not modify the wall plug. Doing so will void the warranty and safety features



If the wall plug does not fit into your local power socket, hire an electrician to replace the socket or purchase an adapter.



This equipment should be installed near the AC outlet and the device should be easily accessible in case power needs to be quickly disconnected.

Warranty

This product has a two (2) year warranty from the date of original purchase.

The warranty will be void if a serial number has been removed from the product.

Upon determination of a legitimate defect covered by this warranty and at MuxLab's sole discretion, the unit will be either repaired or replaced. The user must bear the transport cost to MuxLab, and MuxLab will bear the return cost of the shipment during the warranty period.

If product is out of warranty then a repair charge will be applicable. The repair cost will be determined on a case-by-case basis. MuxLab will repair the faulty out of warranty product after the repair cost has been approved by the Customer and proper financial arrangements are agreed upon. The customer must bear all shipment costs for out of warranty products, including to and from MuxLab.

Return and RMA Policies

Shipments will not be received and processed for warranty repair/replacement without a MuxLab RMA (Return Materials Authorization) number provided by MuxLab.