

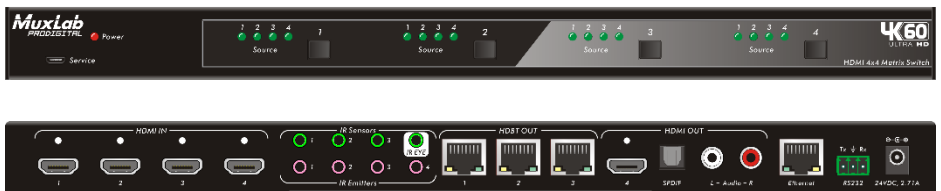

## HDMI 4x4 Matrix Switch Kit, HDBT, PoC, 4K/60

### Installation & Operation Manual

500412



## SAFETY PRECAUTIONS

To insure the best from the product, please read all instructions carefully before using the device. Save this manual for further reference.

- Follow basic safety precautions to reduce the risk of fire, electrical shock and injury to persons.
- Do not dismantle the housing or modify the module. It may result in electrical shock or burns.
- To prevent fire or shock hazard, do not expose the unit to rain, moisture or install this product near water. Keep the product away from liquids.
- Spillage into the housing may result in fire, electrical shock, or equipment damage. If an object or liquid falls or spills on to the housing, unplug the module immediately.
- Do not use liquid or aerosol cleaners to clean this unit. Always unplug the power to the device before cleaning.
- Using supplies or parts not meeting the product's specifications may cause damage, deterioration or malfunction.
- Refer all servicing to qualified service personnel.
- Install the device in a place with good ventilation to avoid damage due to overheating.
- Unplug the power cord when left unused for a long period of time.
- Do not put any heavy items on the unit, nor on the extension cable.
- Do not remove the housing of the device as you may be exposed to dangerous voltage or other hazards.
- Information on disposal of devices: do not burn or mix with general household waste, please treat this device as normal electrical waste.
- Unpack the equipment carefully and save the original box and packing material for possible future shipment.
- Please read this user manual carefully before using the product.

## Contents

|        |   |    |
|--------|---|----|
| 1.1.   | Introduction .....  | 5  |
| 1.2.   | Introduction to the HDMI 4x4 Matrix Switch .....                    | 5  |
| 1.3.   | Features.....   | 5  |
| 1.4.   | Package Content .....   | 6  |
| 2.     | Specification.....  | 7  |
| 2.1.   | HDMI 4x4 Matrix Switch.....   | 7  |
| 2.2.   | HDBT Receiver .....   | 8  |
| 3.     | Panel Description .....   | 9  |
| 3.1.   | HDMI 4x4 Matrix Switch Front Panel .....                            | 9  |
| 3.2.   | HDMI 4x4 Matrix Switch Rear Panel.....                              | 10 |
| 3.3.   | HDBT Receiver Front Panel.....                                      | 11 |
| 3.4.   | HDBT Receiver Rear Panel .....                                      | 11 |
| 4.     | System Connections .....  | 13 |
| 4.1.   | Safety Precautions.....   | 13 |
| 4.2.   | System Diagram .....  | 13 |
| 4.3.   | Connection Procedure .....  | 13 |
| 4.4.   | Connection with the HDBT Receiver.....                              | 14 |
| 5.     | System Operations.....  | 16 |
| 5.1.   | Front Panel Button Control .....                                    | 16 |
| 5.2.   | IR Control.....   | 17 |
| 5.2.1. | IR Remote.....  | 17 |
| 5.2.2. | Force Carrier.....  | 18 |
| 5.2.3. | Control Far-end Displays while being near the Matrix Switch .....   | 18 |
| 5.2.4. | Control Source Devices near the Matrix from a Remote location ..... | 18 |
| 5.3.   | RS232 Control .....   | 20 |
| 5.3.1. | RS232 connection .....  | 20 |
| 5.3.2. | Installing and uninstalling the RS232 Control Software .....        | 20 |
| 5.3.3. | Basic Settings .....  | 20 |
| 5.3.4. | RS232 Communication Commands.....                                   | 20 |
| 5.4.   | TCP/IP Control.....   | 27 |
| 5.4.1. | Control Modes .....   | 27 |

|  |    |
|--|----|
| 5.4.2. Web-Interface GUI for TCP/IP control..... | 28 |
| 5.4.3. GUI Update.....                           | 31 |
| 5.5. EDID Management .....                       | 32 |
| 5.5.1. EDID learning .....                       | 32 |
| 5.5.2. EDID invoking.....                        | 32 |
| 5.6. Firmware Update via USB .....               | 33 |
| 6. Unit Drawing & Dimensions.....                | 34 |
| 6.1. HDMI 4x4 Matrix Switch.....                 | 34 |
| 6.2. HDBT Receiver .....                         | 34 |
| 7. Troubleshooting & Maintenance.....            | 35 |
| Regulatory Compliance .....                      | 38 |

## 1.1. Introduction

### 1.2. Introduction to the HDMI 4x4 Matrix Switch Kit

This product is a professional 4K HDMI/HDBT Distribution Hub Kit, which consists of a HDMI 4x4 Matrix Switch, 3 HDBT Receivers and accessories.

The HDMI 4x4 Matrix Switch is a professional switch that consist of the following inputs and outputs, four (4) HDMI IN ports (4K @ 60Hz), three (3) IR Sensor ports, one (1) IR Eye, four (4) IR Emitter ports, three (3) HDBT OUT ports, one (1) HDMI OUT port, one (1) SPDIF OUT, one (1) Left &Right RCA OUT, one (1) Ethernet port, and one (1) RS232 control port.

The HDBT Receiver is an HDBT Receiver that consists of the following inputs and outputs, one (1) HDBT IN port, one (1) IR Sensor port, one (1) IR Emitter port, and one (1) HDMI OUT port. The receiver is powered directly by the Matrix Switch via PoC.

All HDMI inputs can be selected by either the front panel buttons, IR, RS 232 and TCP/IP. The selected input source may be connected to any or all of the HDBT zoned outputs (outputs 1 through 3) and the Local HDMI output (output 4).

The HDMI 4x4 Matrix Switch is capable of delivering 4K signals up to 40m and 1080p signals up to 70m via HDBT, and powering the receivers via a single UTP cable.

The HDMI 4x4 Matrix Switch supports EDID management and is HDCP 2.2 and 1.4 compliant.

Audio sources can be selected via RS232 and/or TCP/IP commands supported by the Matrix Switch, or by 3rd Party control.

### 1.3. Features

- Supports HDMI 2.0 (4K/60 4:2:0) & HDCP 2.2, and is compliant with lower standards. Capable of transmitting signals up to 4K @ 60Hz (4:2:0) & 1080p 3D.
- Supports manual HDCP management and auto-detecting.
- Transmits a 4K signal up to 8m via the HDMI port, or up to 40m via the HDBT port.
- Audio source is selectable via RS232 and/or TCP/IP commands.
- 3 HDBT outputs, support distances up to 70m at 1080p and 40m at 4K on a single CAT5e/6 cable.
- The HDBT Receivers are powered by the matrix switch via 24VDC PoC technology.
- LED indicators show real-time switching status.
- Controllable via front panel, RS232, IR and TCP/IP.

- Supports bi-directional IR control.
- Built-in Graphical User Interface (GUI) for TCP/IP control.
- Powerful EDID management.
- Supports firmware upgrade through Micro USB port.
- Easy installation, and is rack-mountable.

#### **1.4. Package Content**

- One (1) HDMI 4x4 Matrix Switch
- Three (3) HDBT Receivers
- Four (4) IR Emitters
- Three (3) IR Sensors
- One (1) IR Sensor for the Matrix IR eye port
- One (1) IR Remote
- Two (2) Mounting Brackets and six (6) screws for the Matrix Switch
- Six (6) Mounting Brackets and six (6) screws for the HDBT Receivers
- One (1) RS232 Cable (3-pin Phoenix/Terminal Block to DB9)
- One (1) 24VDC, 2.71A Power Adapter
- One (1) Power Cord
- Four (4) Trapezoidal Plastic Feet for the Matrix Switch
- Twelve (12) Round plastic pads for the HDBT Receivers
- One (1) User Manual

Please verify that the product and the accessories are all included; if not, please contact your dealer.

## 2. Specification

### 2.1. HDMI 4x4 Matrix Switch

|  |   |
|--|---|
| <b>Environment</b>   | HDMI 2.0 (4K/60 4:2:0), HDCP 1.4 & 2.2  |
| <b>Devices</b>   | DVD, projectors, monitors, TVs, PCs, laptops, servers supporting HDMI   |
| <b>Transmission</b>  | Transparent to the user   |
| <b>Video Bandwidth</b>   | 10.2Gbps  |
| <b>Maximum Pixel Clock</b>   | 297Mhz  |
| <b>Video Resolution</b>  | VESA and SMPTE 480p to 2160p (4K) With 3D<br>Bit depth: 16, 20, 24  |
| <b>Signal</b>  | HDMI 2.0 (4K/60 4:2:0) protocol and HDCP 1.4 & 2.2  |
| <b>Switching Speed</b>   | 200ns (Max.)  |
| <b>Audio</b>   | Analog Audio: 2CH PCM<br>Digital Audio: PCM, Dolby TrueHD, DTS-HD Master Audio  |
| <b>Maximum Distance</b><br><i>Based on a maximum length of 6.6ft. (2m) of HDMI cable per end.<br/>Cables not included.</i> | Cat 5e/6: Up to 230ft (70 m) @ 1080p<br>Up to 131ft (40m) @ 4K/30 (4:4:4), or<br>4K/60 (4:2:0)<br><i>Note: When installed in an electrically noisy environment, an STP cable must be used. Also, cross-connections reduce the effective distance depending on the grade of twisted pair cable used.</i>   |
| <b>Cable</b>   | One (1) Cat 5e/6 or better twisted pair cable required.   |
| <b>Control</b>   | Ethernet (TCP/IP & WEB)<br>Serial Port<br>Front Panel Buttons<br>4 IR Emitters, 3 IR Sensors & IR Sensor Extender   |
| <b>Connectors</b>  | Five (5) HDMI connectors for HDMI Input (x4) & Output (x1)<br>Three (3) RJ45 shielded connectors for HDBT<br>Eight (8) 3.5mm Jacks; for IR Sensor & Emitters<br>One (1) 3-pin phoenix/terminal block (3.81 mm) for RS232<br>One (1) TOSLink for digital Audio Output<br>Two (2) RCA Jacks for 2CH audio output<br>One (1) RJ45 Shielded connector for Ethernet<br>One (1) USB Port for firmware upgrade<br>One (1) 2.1mm barrel locking connector for Power |

|                          |  |
|--------------------------|--|
| <b>Power Supply</b>      | One (1) 110-240VAC to 24VDC/2.71A power supply   |
| <b>Power Consumption</b> | 35W (Max.)   |
| <b>Temperature</b>       | Operating: 0° to 50°C      Storage: -20° to 85°C<br>Humidity: Up to 90% non-condensing   |
| <b>Enclosure</b>         | Metal  |
| <b>Dimensions</b>        | 14.17" x 1.10" x 5.91" (360mm x 28mm x 150mm)  |
| <b>Weight</b>            | 2.00 lbs (0.91 kg)   |
| <b>Compliance</b>        | Regulatory: FCC, CE, RoHS  |
| <b>Warranty</b>          | 2 years  |
| <b>Order Information</b> | 500412-US HDMI 4x4 Matrix Switch Kit, HDBT, PoC, 4K/60, US<br>500412-UK HDMI 4x4 Matrix Switch Kit, HDBT, PoC, 4K/60, UK<br>500412-EU HDMI 4x4 Matrix Switch Kit, HDBT, PoC, 4K/60, EU |

## 2.2. HDBT Receiver

|  |  |
|--|--|
| <b>Environment</b>   | HDMI 2.0 (4K/60 4:2:0), HDCP 1.4 & 2.2   |
| <b>Devices</b>   | DVD, projectors, monitors, TVs, PCs, laptops, servers supporting HDMI  |
| <b>Transmission</b>  | Transparent to the user  |
| <b>Video Bandwidth</b>   | 10.2Gbps   |
| <b>Maximum Pixel Clock</b>   | 297Mhz   |
| <b>Video Resolution</b>  | VESA and SMPTE 480p to 2160p (4K) With 3D<br>Bit depth: 16, 20, 24   |
| <b>Signal</b>  | HDMI 2.0 (4K/60 4:2:0) protocol and HDCP 1.4 & 2.2   |
| <b>Maximum Distance</b><br><i>Based on a maximum length of 6.6ft. (2m) of HDMI cable per end. Cables not included.</i> | Cat 5e/6:    Up to 230ft (70 m) @ 1080p<br>Up to 131ft (40m) @ 4K/30 (4:4:4), or<br>4K/60 (4:2:0)<br><br><i>Note: When installed in an electrically noisy environment, an STP cable must be used. Also, cross-connections reduce the effective distance depending on the grade of twisted pair cable used.</i> |



|                          |   |
|--------------------------|---|
| <b>Control</b>           | 1 IR Emitter, 1 IR Sensor   |
| <b>Connectors</b>        | One (1) HDMI connector for HDMI Output<br>One (1) RJ45 shielded connector for HDBT<br>Two (2) 3.5mm Jacks; for the IR Sensor & IR Emitter<br>One (1) 3-pin phoenix/terminal block (3.81 mm) for RS232 |
| <b>Temperature</b>       | Operating: 0° to 50°C      Storage: -20° to 85°C<br>Humidity: Up to 90% non-condensing  |
| <b>Enclosure</b>         | Metal   |
| <b>Dimensions</b>        | 2.40" x 0.95" x 4.71" (61mm x 24mm x 120mm)   |
| <b>Weight</b>            | 0.62 lbs (0.28 kg)  |
| <b>Compliance</b>        | Regulatory: FCC, CE, RoHS   |
| <b>Warranty</b>          | 2 years   |
| <b>Order Information</b> | 500412-RX HDMI Receiver, HDBT, PoC, 4K/60   |

### 3. Panel Description

#### 3.1. HDMI 4x4 Matrix Switch Front Panel



| No. | Name            | Description  |
|-----|-----------------|--|
| 1   | Service         | Used for firmware update.  |
| 2   | Power Indicator | <b>OFF:</b> No power;<br><b>RED:</b> DC power present or Standby Mode  |
| 3   | Input LEDs      | There are a total of 4 groups of 4 LEDs each. Each group is set up with 4 green indicators for the 4 input sources, numbered from "1" to "4".                          |
| 4   | Output Buttons  | There are a total of 4 output selector buttons. Press each button to select which input to connect to the given output. Each button press cycles through the 4 inputs. |

### 3.2. HDMI 4x4 Matrix Switch Rear Panel

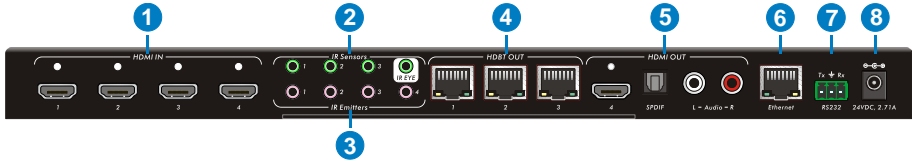

| No. | Name         | Description   |
|-----|--------------|---|
| 1   | HDMI IN      | There are 4 HDMI inputs, which are to be physically connected to the HDMI source devices.   |
| 2   | IR Sensors   | <ul style="list-style-type: none"> <li>There are 3 IR Sensor ports: These 3 ports should be connected to the IR Sensors. These are fixed IR inputs and correspond to the same fixed outputs, and cannot be switched separately. This allows for an IR transmission to the IR Emitter on the corresponding HDBT receiver.</li> <li>There is 1 IR Eye: This should be connected to the extended IR Sensor, and allows the IR remote to control the HDMI Matrix Switch.</li> </ul> |
| 3   | IR Emitters  | <ul style="list-style-type: none"> <li>These 3 ports should be connected to the IR Emitters and attach to the front of each source. They emit the IR signal received from each HDBT Receiver.</li> </ul>  |
| 4   | HDBT OUT     | There are 3 RJ45 outputs, used to deliver HD video, audio and PoC to the HDBT Receivers, at up to 70m.  |
| 5   | HDMI OUT     | <ul style="list-style-type: none"> <li>HDMI: There is 1 HDMI port which may be connected to a local display.</li> <li>SPDIF: Digital audio output connects directly via an optical fiber cable to the Toslink input on a sound bar.</li> <li>RCA (2CH, L&amp;R): PCM Analogue audio output connectors (line level), used to connect to self-powered speakers or an amplifier.</li> </ul>  |
| 6   | Ethernet     | Connects with a PC over the network for TCP/IP & Web-based GUI control.   |
| 7   | RS232        | RS232: Serial port for local unit control via a PC with terminal software. Uses a 3-pin pluggable terminal block to connect with the control device (e.g. PC).  |
| 8   | 24VDC, 2.71A | 24 VDC power connector. Connects to the included  |

| No. | Name | Description                 |
|-----|------|-----------------------------|
|     |      | 24VDC power supply adapter. |

### 3.3. HDBT Receiver Front Panel

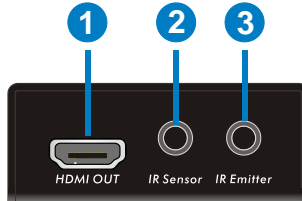

| No. | Name            | Description  |
|-----|-----------------|--|
| 1   | HDMI OUT        | Connects to a HDMI display.  |
| 2   | IR Sensor Port  | Connects to the IR Sensor, which receives the IR signal from the remote control unit, and sends this signal through to the Matrix Switch and in turn is passed on to control the desired source. |
| 3   | IR Emitter Port | Connects to the IR Emitter, which is attached to the front of the display. This will send the IR signals received from the Matrix Switch in order to control the display.                        |

### 3.4. HDBT Receiver Rear Panel

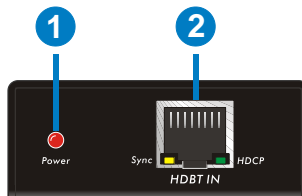

| No. | Name            | Description   |
|-----|-----------------|---|
| 1   | Power Indicator | <b>OFF:</b> No power.<br><b>RED:</b> DC power present (PoC).  |
| 2   | HDBT IN         | The RJ45 connector has two LEDs status indicators. Connect a RJ45 patch cord between the HDBT Receiver and the Matrix Switch. <ul style="list-style-type: none"> <li><b>HDCP:</b> HDCP compliant indicator. <ul style="list-style-type: none"> <li>❖ OFF: No HDMI traffic (no video)</li> </ul> </li> </ul> |

| No. | Name | Description   |
|-----|------|---|
|     |      | <ul style="list-style-type: none"><li>◇ GREEN: Video traffic with HDCP.</li><li>◇ Blinking GREEN: Video traffic without HDCP</li><li>• <b>Sync:</b> HDBT Link status indicator.<ul style="list-style-type: none"><li>◇ OFF: No Link</li><li>◇ YELLOW: Link Successful</li><li>◇ Blinking YELLOW: Link Error</li></ul></li></ul> |

## 4. System Connections

### 4.1. Safety Precautions

The system should be installed in a clean environment with temperature and humidity levels within the specified operating range.

Ensure that all plugs, power cords and sockets are in good condition without signs of damage.

All devices should be connected before turning on the power.

### 4.2. System Diagram

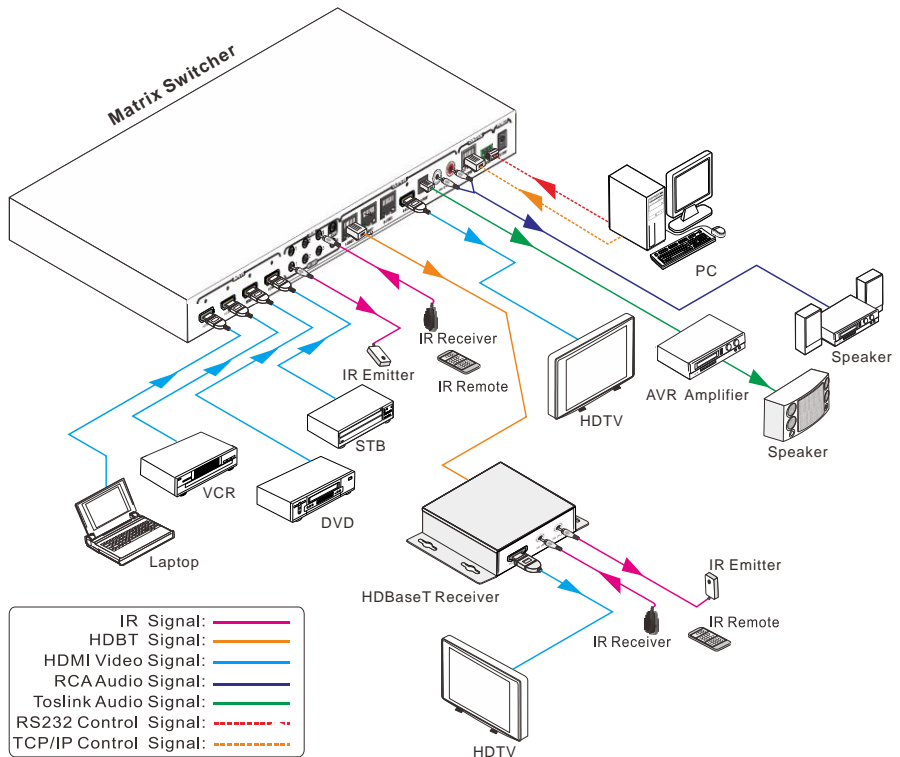

### 4.3. Connection Procedure

- Connect an HDMI source device (e.g. Blu-Ray player) to the **HDMI Input** connectors of the HDMI 4x4 Matrix Switch, with an HDMI cable.
- Connect an HDMI display to the **HDMI Output** connector of the HDMI 4x4 Matrix Switch, with an HDMI cable.

- c) Connect up to three (3) HDBT Receiver(s) to the HDBT Link output port(s) of the HDMI 4x4 Matrix Switch, with a UTP Cable.
- d) An AVR amplifier with a TOSLink Optical Cable may be connected using the SPDIF output port.
- e) Self-powered speakers may be connected to RCA Jacks (L&R) output port using an audio cable.
- f) Connect the controlling device (e.g. PC) to the **RS232 Input** port of the HDMI 4x4 Matrix Switch, with the supplied RS232 cable.
- g) Connect a Patch cord from the router to the Ethernet port on Matrix Switch to control the Matrix Switch using TCP/IP protocol or a WEB GUI.
- h) Connect an IR Sensor to the **IR Sensor** port, and an IR Emitter to the **IR Emitter** port. The IR signal can be transmitted bi-directionally between the HDMI 4x4 Matrix Switch and the HDBT Receiver(s).
- i) Connect the included DC 24V power adapter to the power port of the 500412.

**Note:**

1. Connect the HDBT ports of the Matrix Switch and far-end HDBT Receiver with straight-through cable.
2. IR Sensors connected to the IR Sensor Inputs should support a carrier-wave signal. If the IR sensor does support carrier-wave then, send the command “%0900.” to activate native carrier mode. However, if the IR sensor does not support carrier-wave, then send the command “%0901.” to activate and force the IR Matrix to send a carrier-wave signal to the far-end HDBT Receiver.

**4.4. Connection with the HDBT Receiver**

The Matrix Switch has 3 HDBT outputs which support PoC technology. Connect a Cat 5e/6 patch cord to the HDBT Outputs and connect it to the pre-installed infrastructure. Connect HDBT Receivers to the pre-installed cabling via additional patch leads. Plug the power supply in to the power socket on the matrix, the HDBT Receivers will be powered by the 500412 Matrix Switch.

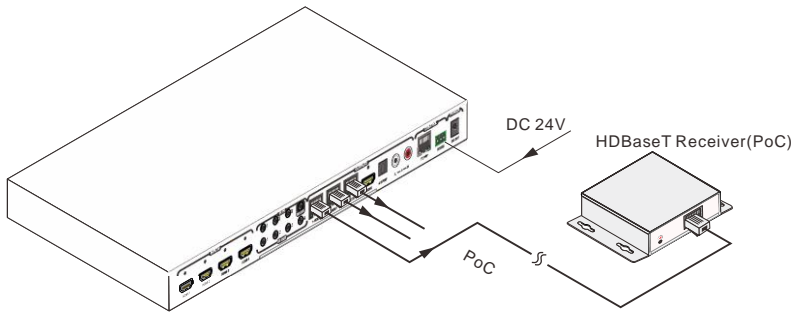

## 5. System Operations

### 5.1. Front Panel Button Control

The HDMI 4x4 Matrix Switch can be controlled via the front panel. Please follow the basic programming instructions below:

#### 1. To connect one input to an output:

Example: Input 1 to Output 3

→ Press the Output 3 button until the Input 1 LED is ON

#### **NOTE:**

Default status, on first boot up this matrix assigns the IR outputs to the corresponding HDMI input, meaning, IR out 1 is directly associated to HDMI input 1 and so on. When you switch an HDMI input to a different output, the corresponding IR OUT will be switched synchronously to allow the IR commands to be sent from the select zone back through the Matrix Switch to the source.

#### 2. To connect one input to several outputs:

Example: Connect Input 2 to Output 3 and 4

→ Press the Output 3 button until the Input 2 LED is ON

→ Press the Output 4 button until the Input 2 LED is ON

#### 3. To connect an input to all the outputs:

Example: Input 1 to all Outputs

→ Press the Output 1 button until the Input 1 LED is ON

→ Press the Output 2 button until the Input 1 LED is ON

→ Press the Output 3 button until the Input 1 LED is ON

→ Press the Output 4 button until the Input 1 LED is ON

**Note:** LED Indicators of the pressed buttons above will blink green for three times if the connections were completed successfully, then the LED will switch OFF. If the connection failed, they the LEDs will turn OFF immediately.



## 5.2. IR Control

### 5.2.1. IR Remote

Connect an IR receiver to the **IR EYE** port of the Matrix Switch, users can control it through the included IR remote. Here is a brief introduction to the IR remote.

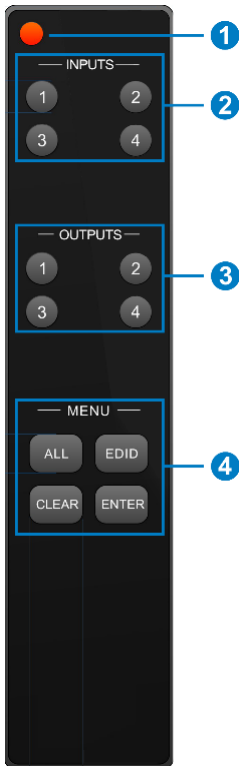

- ① Standby button, press it to enter/exit standby mode.
- ② **INPUTS:**  
There are four (4) Input channel selection buttons. The corresponding IR signal port switches synchronously when switching input channels.
- ③ **OUTPUTS:**  
Output channel selection buttons.
- ④ **Menu buttons: ALL, EDID, CLEAR and ENTER.**
  - **ALL:** Select all outputs.
  - **EDID** management button: Enables the Input port to manually capture and learn the EDID data of output devices.
  - **CLEAR:** Cancel an operation in progress, before it have been completed, such as switching an output channel. Pressing this button will return the Matrix to its previous status.
  - **ENTER:** Confirms/executes an operation.

By using the IR Remote & HDBT transmission technology, the 4K Home Distribution Hub Kit supports the following capabilities:

- 1) Locally control a far-end output device.
- 2) Control local input/output devices remotely.
- 3) Control the Matrix Switch, either locally or remotely.

### 5.2.2. Force Carrier

- a) An IR signal received by the Matrix Switch IR In port, which is coming from the HDBT Receiver with a connected IR sensor, will only be transferred to the Matrix Switch IR Out port, if the IR sensor connected to the HDBT receiver supports IR carrier-wave.
- b) An IR signal received by the Matrix Switch IR In port, which is coming from a directly connected IR sensor, will only be transferred to the Matrix Switch IR Out port, if the IR sensor supports an IR carrier-wave.

Note: If the IR sensor connected to the HDBT receiver or directly to the Matrix Switch does not support carrier-wave, send the command “%0901.” to force enable infrared carrier mode (force enable carrier-wave mode). Doing so allows the IR signal to be transferred through the Matrix Switch to the IR Out port.

### 5.2.3. Control Far-end Displays while being near the Matrix Switch

Connect an IR sensor with IR carrier-wave to the IR IN port of the Matrix Switch. This allows a user local to the Matrix Switch to control far-end displays via an IR remote.

In this case, the IR signal is transferred via HDBT over twisted pair to the remote location. In the case of IR signals going from the source to sink direction, only the corresponding IR OUT port (with the same port number as the IR In) can emit the IR control signal to the remote display. Thus IR In 1 to HDBT Receiver 1, IR In 2 to HDBT Receiver 2, and IR In 3 to HDBT Receiver 3.

See the figure below:

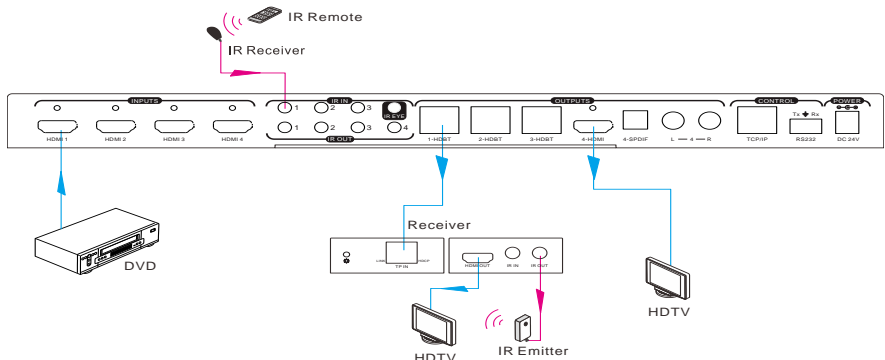

#### Control a far-end device from a position Local to the Switch

Note: The IR sensor connected to IR IN must support an IR carrier-wave signal.

### 5.2.4. Control Source Devices near the Matrix from a Remote location

The Matrix Switch supports two internal matrix switches, one for the Audio/Video signal (AV Matrix) and one for the IR signal (IR Matrix). These two matrices can be switch

independently or together depending on the command used as shown below.

- The command “[x1]V[x2] transfers the AV (only) signal from the input channel [x1] to one or several output channels [x2] (separate output channels with a comma). In this case only the AV Matrix is switched, the IR Matrix is not switched.
- The command “[x1]B[x2] transfers the AV and IR signal from the input channel [x1] to one or several output channels [x2] (separate output channels with a comma). In this case both the AV Matrix and the IR Matrix are switched. Thus the IR signal will follow the existing AV connection path for input [x1] and output [x2].
- The command “[x1]R[x2] transfers the IR (only) signal from the input channel [x1] to the output channel [x2]. In this case only the IR Matrix is switched, the AV Matrix is not switched.

Thus the IR signal path may be different than the AV connection path, depending on the command used.

In all cases above connect IR sensor(s) to the IR IN port on the far-end HDBT receiver(s), and IR Emitter(s) to the IR OUT ports of the Matrix Switch. This allows a user who is remote from the Matrix Switch to be able to control source devices local to the Matrix Switch. Use the IR remote control of the source at the remote location.

Note: If the IR sensor connected to IR IN of the HDBT Receiver does not support carrier-wave, then Send command “%0901.” to force infrared carrier-wave mode.

The 4 “IR OUT” ports on the Matrix Switch and the 3 “IR IN” ports on the far-end HDBT Receivers make up the 4x3 IR matrix. See figure below:

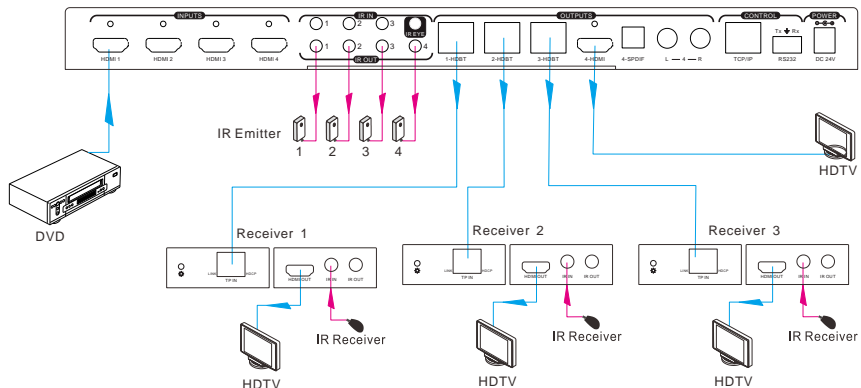

### IR Matrix

The IR signal is sent by IR remote, then it is transferred to HDBT receiver, then to

corresponding zone of the matrix through the twisted pair, finally it is transferred and switched to the IR OUT port of the Matrix Switch and received by controlled device.

### 5.3. RS232 Control

#### 5.3.1. RS232 connection

The Matrix Switch can be controlled remotely through the RS232 communication port. This RS232 communication port is a 3-pin phoenix connector. The supplied Phoenix to 9-pin D-Sub adapter may be used with an RS232 cable to connect to the RS232 port of a PC, see figure below:

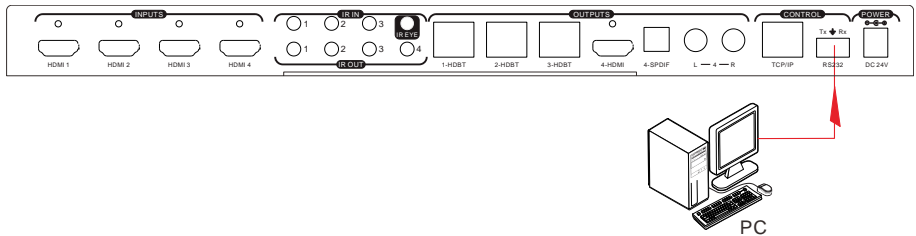

#### 5.3.2. Installing and uninstalling the RS232 Control Software

- **Installing** Create a directory on the computer connected to the Matrix Switch and copy the RS232 control software files to this directory.
- **Uninstalling** Simply delete the RS232 control software files from the corresponding file path.

#### 5.3.3. Basic Settings

Begin by first connecting the Matrix Switch with an input and an output device. Then, connect it to a computer, running the installed RS232 control software.

Please set the correct parameter for the COM port, and set the baud rate as 9600, data bits as 8 bits, stop bit as 1 bit, and the parity bit to none, in order to be able to send RS232 commands.

#### 5.3.4. RS232 Communication Commands

**Note:**

- 1) In the below RS232 commands, the square brackets “[” and “]” are only symbols to help describe the RS232 command syntax, and they do not need to actually be typed in when entering a command.
- 2) Please remember to end each command with the ending symbols “.” and “;”.
- 3) Type each command in carefully, as they are case-sensitive.

4) Please disconnect all the twisted pairs before sending command EDIDUpgrade[X].

RS232 Port Settings:

Baud rate: 9600

Data bit: 8

Stop bit: 1

Parity bit: none

| Command                   | Function  | Feedback Example  |
|---------------------------|---|---|
| <b>System Commands</b>    |   |   |
| /*Type;                   | Returns the model information.  | XXXXX   |
| /%Lock;                   | Lock the front panel buttons on the Matrix.   | System Locked!  |
| /%Unlock;                 | Unlock the front panel buttons on the Matrix.   | System Unlock!  |
| /^Version;                | Returns the version of the firmware   | VX.X.X  |
| Demo.                     | Switch to "demo" mode, connecting inputs to outputs in sequential order of all permutation, such as 1B1, 1B2, ...4B3, 4B4, 1B1... and so on. The switching interval is 2 seconds, and restarts when it reaches the end. | Demo Mode<br>AV:01->01, IR:01->01<br>AV:01->02, IR:01->02<br>.....<br>AV:04->04, IR:04->04<br>AV:01->01, IR:01->01<br>..... |
| <b>Operation Commands</b> |   |   |
| [x]All.                   | Transfer signals from the input channel [x] to all output channels  | X To All. (X=01~04)   |
| All#.                     | Transfer all input signals to the corresponding output channels, such as 1->1, 2->2...  | All Through.  |
| All\$.                    | Switch off all the output channels.   | All Closed.   |
| [x]#.                     | Transfer signals from the input channel [x] to the output channel [x].  | X Through (X=01~04)   |
| [x]\$.                    | Switch off the output channel [x].  | X Close (X=01~04)   |
| [x]@.                     | Switch on the output channel [x].   | X Open (X=01~04)  |
| All@.                     | Switch on all output channels.  | All Open.   |
| [x1]V[x2].                | Transfer the AV signal from the input channel [x1] to one or several output channels ([x2], separate output channels with a comma).   | AV: X1-> X2 (X1/X2=01~04)   |
| [x1]B[x2].                | Transfer the AV and IR signal from input channel [x1] to one or several output channels ([x2], separate output channels   | AV: X1-> X2 (X1/X2=01~04)   |

| Command           | Function  | Feedback Example   |
|-------------------|---|--|
|                   | with a comma).  |  |
| [x1] R[x2].       | Transfer the IR signal from output [x1] to input [x2].  | IR: X1-> X2<br>(X1, X2=01~04)  |
| Status[x].        | Check the I/O connection status of output [x]   | AV: Y-> X<br>(X=01~04,<br>Y=01~04)                                       |
| Status.           | Return the status of the input channel to the output channel connectivity, one at a time.   | AV: 01->01<br>... ..<br>AV: 04->04<br>IR: 01->01<br>... ..<br>IR: 04->04 |
| Save[Y].          | Save the present operation to the preset command [Y], ranges from 0 to 9.   | Save To FY<br>(Y=0-9)  |
| Recall[Y].        | Recall the preset command [Y].  | Recall From FY<br>(Y=0-9)  |
| Clear[Y].         | Clear the preset command [Y].   | Clear FY<br>(Y=0-9)  |
| PWON.             | System is powered on and working (normal operation mode).   | PWON   |
| PWOFF.            | System enters standby mode and cuts off PoC power to the HDBT Receivers.  | PWOFF  |
| STANDBY.          | System enters into standby mode, but does not cut off PoC power to the HDBT Receivers. Press other buttons or send other commands to start the process.   | STANDBY  |
| /%[Y]/[X]:[Z].    | HDCP management command.<br>[Y] is used to select an input port (Y = I) or an output port (Y = O); [X] is used to set the port number (may be set to port 1, 2, 3, 4, or ALL), if X = ALL, then all ports are selected; [Z] is used to decide if a port is HDCP compliant or not, if Z = 1 then port is HDCP compliant, but if Z = 0 then port is not HDCP compliant. | /%[Y]/[X]:[Z].   |
| DigitAudioON[x].  | Enable HDMI audio output of port x.<br><ul style="list-style-type: none"> <li>● For X=1, 2, 3 or 4 will enable this port.</li> <li>● For X=5 will enable all the 4 ports.</li> </ul>  | DigitAudio ON with [x]   |
| DigitAudioOFF[x]. | Disable HDMI audio output of port x.  | DigitAudio OFF with  |

| Command          | Function  | Feedback Example |
|------------------|---|------------------|
|                  | <ul style="list-style-type: none"> <li>● For X=1, 2, 3 or 4 will disable this port.</li> <li>● For X=5 will disable all the 4 ports.</li> </ul>   | [x]              |
| /+[Y]/[X]:*****. | <p>Sets the RS232 communication between the PC and the HDBT receiver.<br/> Note: This command is only applicable with HDBT Receivers supporting an RS232 port, otherwise it does not apply.</p> <p>① Y points to the Matrix port number connected to a given HDBT receiver supporting an RS232 port.<br/> Y= (1 to 3 &amp; 5) or (A to G), The value of Y is defined as follows:</p> <ol style="list-style-type: none"> <li>a. Y = (1 to 3), sends this command to the corresponding HDBT receiver to control the far-end device.</li> <li>b. Y = 5, sends this command to all HDBT receivers to control the corresponding far-end devices.</li> <li>c. Y = A, B, or C</li> <li>d. Y = E, F, or G</li> </ol> <p>For items “c” or “d” above, sends this command, but it will only be saved to the Matrix Switch and no action will be taken by the corresponding HDBT receiver. This command will actually be sent at about the same time as you send the PWON command (for item “c”) or PWOFF command (for item “d”).</p> <p>Note: A &amp; E are for port 1, B &amp; F are for port 2, and C &amp; G are for port 3.</p> <p>② X is used to set the baud rate. Its value ranges from 1 to 7 (where 1=2400, 2=4800, 3=9600, 4=19200, 5=38400, 6=57600, and 7=115200).</p> <p>③ ***** is used for data (max 48 Bytes).</p> | *****            |
| EDIDH[x]B[y].    | <p>Input port [y] learns the EDID from output port [x].<br/> If the EDID data is available and the audio portion supports more than just PCM mode, then force-set it to support only</p>  | EDIDH[x]B[y]     |

| Command            | Function   | Feedback Example                                    |
|--------------------|--|---|
|                    | PCM mode. If the EDID data is not available, then set it to the initial default EDID data.   |   |
| EDIDPCM[x].        | Set the audio part of input port [x] to PCM format in EDID database.   | EDIDPCM[x]  |
| EDIDG[x].          | Get EDID data from output [x] and display the output port number.  | Hexadecimal EDID data and carriage return character |
| EDIDMInit.         | Restore the factory default EDID data on all inputs.   | EDIDMInit.  |
| EDIDM[X]B[Y].      | Enable input[Y] to learn the EDID data of output[X]. If the EDID data is not available, then set it to the initialized EDID data.  | EDIDM[X]B[Y]  |
| EDIDUpgrade[x].    | Update the EDID data via the RS232 port. [x] is used to select the input port, when the value of X = 5, then all input ports are selected. When the switch receives this command, it will show a message to prompt you to send the EDID file (.bin file). Note that the operation will timeout after 10 seconds. Please disconnect all HDBT ports beforehand.  | Please send the EDID file                           |
| EDID/[x]/[y].      | Set the EDID data of input port [x] to built-in EDID number [y]. [y] = (1 to 5), which corresponds to the 5 embedded EDID data values  | EDID/[x]/[y]  |
| UpgradeIntEDID[x]. | Update one of the 5 embedded EDID data values, x is the number representing the EDID data:<br><ol style="list-style-type: none"> <li>1. 1080P 2D 2CH</li> <li>2. 1080P 3D 2CH</li> <li>3. 1080P 2D Multichannel</li> <li>4. 1080P 3D Multichannel</li> <li>5. 3840x2160 2D (30Hz)</li> </ol> When the switch gets this command, it will show a message to send the EDID file (.bin file) to update the corresponding | Please send the EDID file                           |



| Command          | Function   | Feedback Example                      |
|------------------|--|---------------------------------------|
|                  | EDID data. Note that the operation will timeout after 10 seconds.  |                                       |
| GetIntEDID[x].   | Reset the EDID date to the default setting for position number x, where [x] = (1 to 5)                           |                                       |
| GetInPortEDID[X] | Reset the EDID data to the default setting on input [x], where [x] = (1 to 4)                                    |                                       |
| %0801.           | Set to auto HDCP management, and activate carrier native mode (when the IR sensor supports carrier-wave)         | %0801                                 |
| %0900.           | Switch to carrier native mode (when the IR sensor supports carrier-wave).  | Carrier native                        |
| %0901.           | Switch to force carrier-wave mode (when the IR sensor does not support carrier-wave).                            | Force carrier                         |
| %0911.           | Reset the switch to factory default.   | Factory Default                       |
| %9951.           | Check the command sent by port 1 when PWON. Note: Only applicable with HDBT Receivers supporting an RS232 port.  | Port 1: data when PWON                |
| %9952.           | Check the command sent by port 2 when PWON. Note: Only applicable with HDBT Receivers supporting an RS232 port.  | Port 2: data when PWON                |
| %9953.           | Check the command sent by port 3 when PWON. Note: Only applicable with HDBT Receivers supporting an RS232 port.  | Port 3: data when PWON                |
| %9955.           | Check the command sent by port 1 when PWOFF. Note: Only applicable with HDBT Receivers supporting an RS232 port. | Port 1: data when PWOFF               |
| %9956.           | Check the command sent by port 2 when PWOFF. Note: Only applicable with HDBT Receivers supporting an RS232 port. | Port 2: data when PWOFF               |
| %9957.           | Check the command sent by port 3 when PWOFF. Note: Only applicable with HDBT Receivers supporting an RS232 port. | Port 3: data when PWOFF               |
| %9961.           | Check the system locking status.   | System Locked/<br>Unlock!             |
| %9962.           | Check the power status   | STANDBY/PWOFF/<br>PWON                |
| %9963.           | Check the working mode of the infrared carrier.  | Carrier native/ Force<br>carrier-wave |

| Command      | Function  | Feedback Example  |
|--------------|---|---|
| %9964.       | Check the switch IP address.  | IP:192.168.0.178<br>(default)   |
| %9971.       | Check the connection status of the inputs. Shows which input ports are connected, where Y is for yes and N is for no.   | In     01 02 03 04<br>Connect Y   Y   Y   Y   |
| %9972.       | Check the connection status of the outputs. Shows which output ports are connected, where Y is for yes and N is for no. | Out     01 02 03 04<br>Connect Y   Y   Y   Y  |
| %9973.       | Check the HDCP status of the inputs, where Y is for yes and N is for no.  | In           1 2 3 4<br>HDCP        N N N N   |
| %9974.       | Check the HDCP status of the outputs, where Y is for yes and N is for no.   | Out           1 2 3 4<br>HDCP        N N N N  |
| %9975.       | Check the I/O connection status. Shows which input is connected to each of the 4 outputs.                               | Out 01 02 03 04<br>In    04 04 04 04  |
| %9976.       | Check the output resolution.  | Out 1   1920x1080<br>Out 2   1920x1080<br>Out 3   1920x1080<br>Out 4   1920x1080      |
| %9977.       | Check the status of digital audio of the output channels, where Y is for yes and N is for no.                           | Out           1 2 3 4<br>Audio        Y Y Y Y   |
| %9978.       | Check the HDCP compliant status of the inputs, where Y is for yes and N is for no.                                      | In           01 02 03 04<br>HDCPEN Y   Y   Y   Y                                      |
| I-Lock[X].   | Lock the channel [x], where X = (1 to 4)  | Channel[x] Lock!  |
| I-Unlock[X]. | Unlock the channel [x], where X = (1 to 4)  | Channel[x] Unlock!  |
| A-Lock.      | Lock all channels   | All Channel Lock!   |
| A-UnLock.    | Unlock all channels   | All Channel Unlock!   |
| Lock-Sta.    | Check the lock status of all channels.  | Channel 1->1 Lock!<br>Channel 1->2 Lock!<br>.....<br>Channel 2->1<br>Unlock!<br>..... |

## 5.4. TCP/IP Control

In addition to supporting IR and RS232 control, the Matrix Switch also supports TCP/IP control.

**The default settings are: IP: 192.168.0.178; Subnet Mast: 255.255.255.0; Gateway: 192.168.0.1; Serial Port: 4001.**

The IP and gateway settings can be changed as needed, but the Serial Port value cannot be changed.

Connect the Ethernet port of the control device (such as a PC) and the Ethernet port of the Matrix Switch to the same network segment. This allows the user to control the Matrix Switch via the units web-interface GUI or designed TCP/IP communication software.

### 5.4.1. Control Modes

The Matrix Switch can be controlled by a PC without a network connection (via a direct connection) or by one or more PCs within a LAN.

- **Controlled by PC (with a direct connection)**

Connect a computer's Ethernet port directly to the Ethernet port of the Matrix Switch, and set the PC's network segment to the same as the Matrix Switch's.

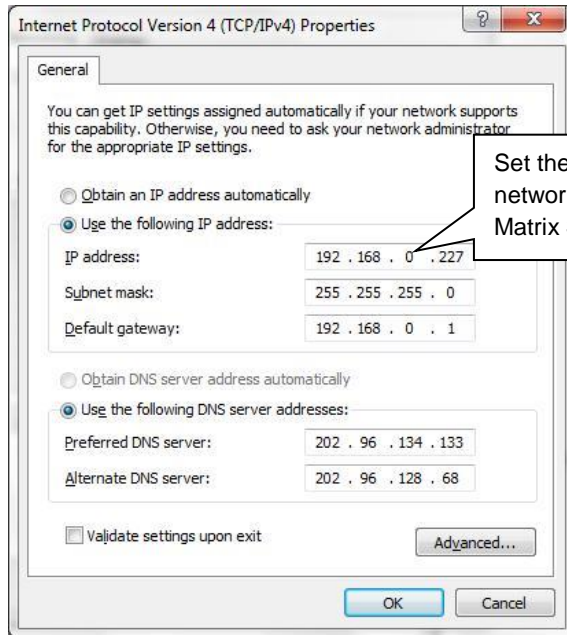

### ● Controlled by PC(s) in LAN

Connect the Matrix Switch to a Router or Ethernet Switch and one or more PCs to the same network to setup a LAN (as shown in the figure below). Set the network segment of the Matrix Switch and PC(s) to the same segment set in the Router or Ethernet Switch. This then allows the PC(s) within the LAN to control the Matrix Switch.

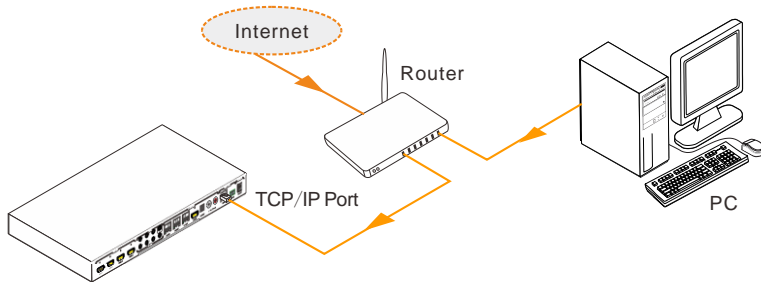

Follow these steps to connect the devices:

- Step1.** Connect the Ethernet port of the Matrix Switch to the Ethernet port of the PC with a Cat 5e/6 twisted pair Ethernet cable.
- Step2.** Set the PC's network segment to the same as the Matrix Switch's. However if the PC has the same network segment as the Router or Ethernet Switch then please take note of the PC's original network segment before changing it, since you will need to change it back later on.
- Step3.** With the PC communicating to the web interface of the Matrix Switch, set the Matrix Switch's network segment to the same as that of the Router or Ethernet Switch.
- Step4.** Set the PC to the same network segment of the Router or Ethernet Switch. If the original one was already the same as the Router or Ethernet Switch, then simply return the PC's network segment to its original one you recorded above.
- Step5.** Connect the Matrix Switch and PC(s) to the Router or Ethernet Switch. PC(s) within the LAN are able to then control the Matrix Switch through its web-interface GUI.

#### 5.4.2. Web-Interface GUI for TCP/IP control

The 4K Home Distribution Hub Kit supports a web-interface GUI for convenient TCP/IP control. The GUI allows users to interact with this Kit through graphical icons and visual indicators.

Type <http://192.168.0.178> in your browser, to bring up the log-in interface shown below:

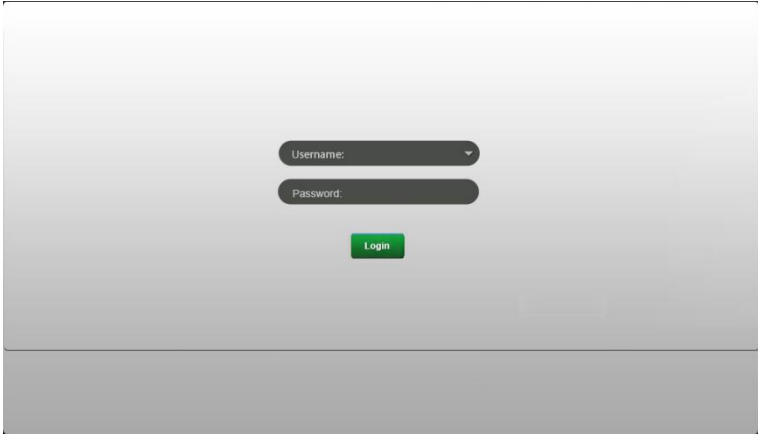

There are 2 default operators which may be selected to manage the system – “admin” (default password: admin) and “user” (default password: user). Logging in as an “admin” provides more access and configuration rights than logging in as a “user”. Enter the correct username and password.

The following provides a brief introduction to the interfaces.

**Main Screen:** The main screen provides an intuitive I/O connection/switching interface. See the screenshot below:

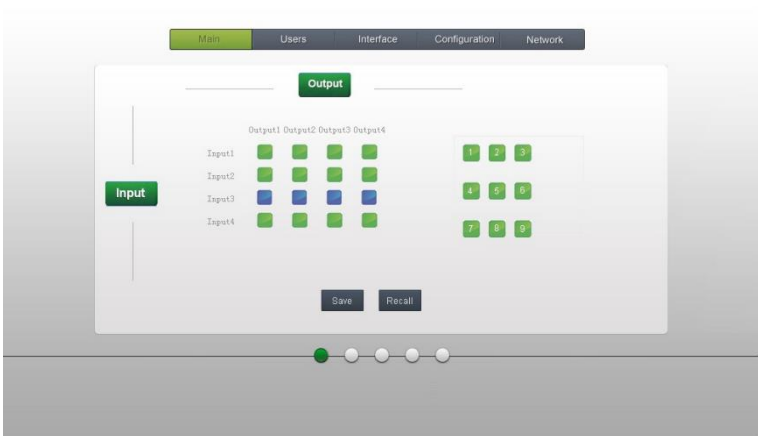

The matrix grid displays all possible connections between each input and output. Users can make connections by clicking on the corresponding grid button.

Buttons 1 to 9 on the right-side provides a quick way to saving and recalling the overall connection setting/status.

**Users Screen:** Modify the username and password credential settings, display the front panel lock status, and display the GUI version.

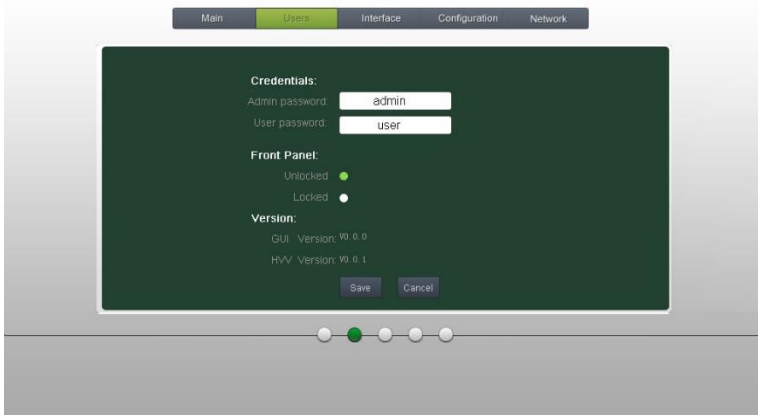

If there are any changes made, make sure you press Save to record and accept the changes, or press Cancel to undo these changes.

**Interface Screen:** Set the title bar label and input/output port button labels. Press Save to record and accept any changes made to these settings.



**Configuration Screen:** Set HDCP Compliance setting for every input, and manage EDID. See the screenshot below for further details:



**Network Screen:** View and configure the network settings, including MAC address, IP address, subnet mask, and Gateway

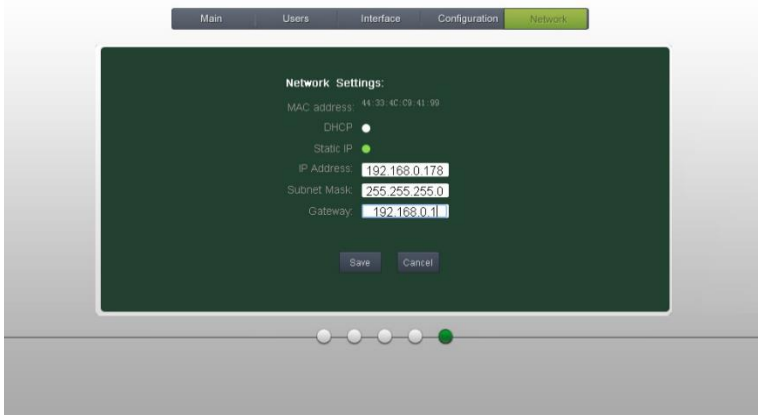

**Note:** Logging in as “user”, provides access to the Main Screen interface only.

### 5.4.3. GUI Update

The web GUI for the 4K Home Distribution Hub Kit supports online updates. Type in <http://192.168.0.178:100> in to your browser to access this page. You will need to enter your username and password (the same one used for the web GUI log-in, modified password will be available only after rebooting) to log in to the configuration interface. Next click **Administration** on the main menu, and then on **Upload Program** as shown below:

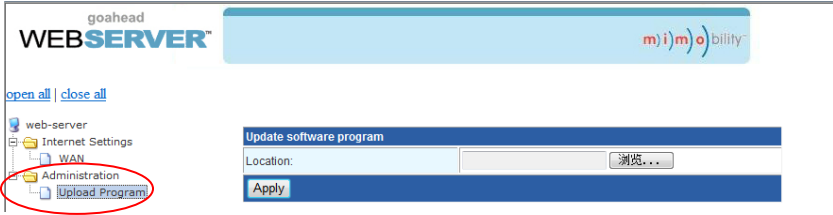

Select the desired update file and press Apply. This will start the upgrade process.

## 5.5. EDID Management

The Matrix Switch features EDID management to maintain compatibility between all devices. The system supports EDID learning and EDID setting (invoking).

### 5.5.1. EDID learning

The included IR remote can be used to enable the Matrix Switch to learn the EDID of each sink devices (such as displays).

✓ **One input port can learn the EDID data from one output port:**

Example: Input 2 learns EDID data from output 4

→ Press EDID + INPUTS 2 + OUTPUTS 4 + ENTER

✓ **All input ports can learn the EDID data from one output port:**

Example: all input ports learn EDID data from output 4

→ Press: EDID + ALL + OUTPUTS 4 + ENTER

### 5.5.2. EDID invoking

There are five settings of embedded EDID data. The chart below details each of them:

| No. | EDID Data             |
|-----|-----------------------|
| 1   | 1080P 2D 2CH          |
| 2   | 1080P 3D 2CH          |
| 3   | 1080P 2D Multichannel |
| 4   | 1080P 3D Multichannel |
| 5   | 3840x2160 2D (30Hz)   |

Send the RS232 command “UpgradeIntEDID[x].” via the RS232 Control Software to upgrade the embedded EDID data, where the value range for [x] is from 1 to 5 and corresponds to the EDID data as shown above.



## 5.6. Firmware Update via USB

The Matrix Switch boasts a USB port on the front panel for firmware upgrades. Follow these steps to upgrade the firmware:

**Step1.** From the MuxLab website, copy the software upgrade utility and the latest Matrix Switch firmware upgrade file (.bin) to your PC.

**Step2.** Connect the USB port of the Matrix Switch to the USB port of your PC via an appropriate USB cable.

**Step3.** Double-click on the software upgrade utility icon (see as below).



This action will bring up the window shown below:

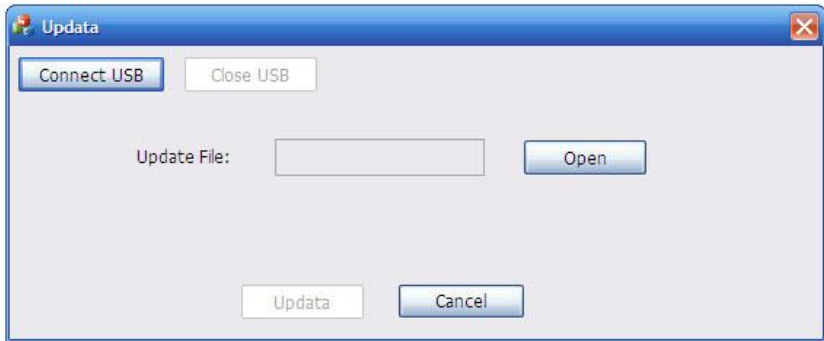

**Step4.** Click **Connect USB**.

**Step5.** Click **Open** to search for and load the Matrix Switch firmware upgrade file, then click **Updata** to start the firmware upgrade process.

**Note:** To ensure proper RS232 connectivity and control, ensure that the COM number of the PC be within the range (1 to 9).

## 6. Unit Drawing & Dimensions

### 6.1. HDMI 4x4 Matrix Switch

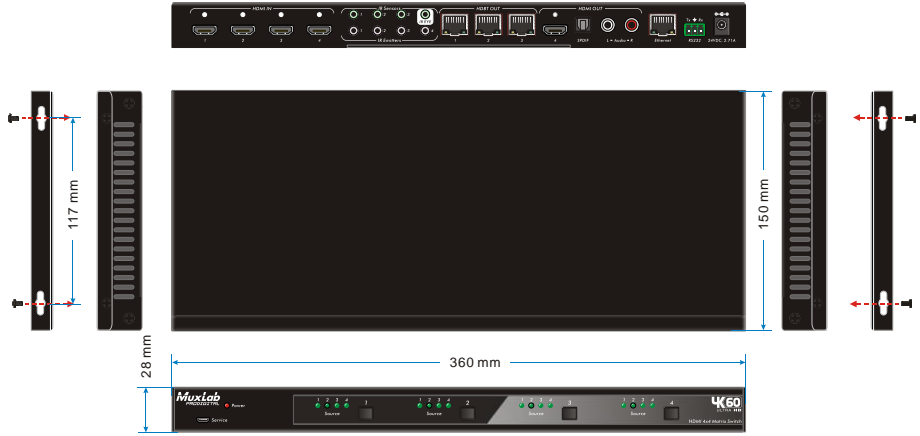

### 6.2. HDBT Receiver

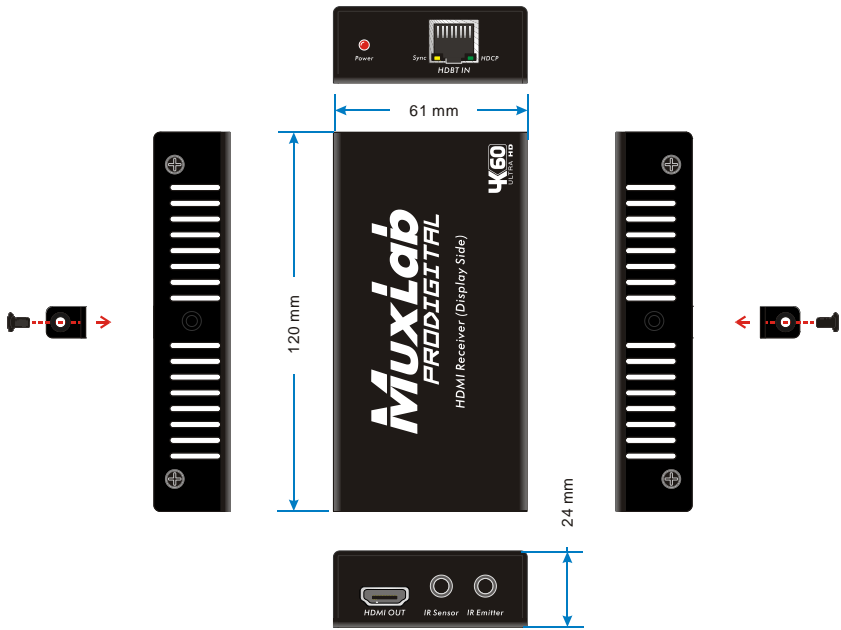

## 7. Troubleshooting & Maintenance

The following table describes some of the symptoms, probable causes and possible solutions with respect to the installation of the 500412 HDMI 4x4 Matrix Switch.

| Problems  | Causes  | Solutions   |
|---|---|---|
| Losing color or no video signal output.                       | The connecting cables may not be connected correctly or may be damaged.                             | Check whether the cables are connected correctly and in good condition.                             |
|   | Faulty or loose connection.   | Make sure there is a good connection.   |
| No output image when switching.                               | No signal at the input / output end.  | Check with another sink device if there is any signal at the input / output end.                    |
|   | Faulty or loose connection.   | Make sure there is a good connection.   |
|   | Input source supports HDCP, but the Matrix Switch HDCP compliance setting is switched off.          | Send the RS232 command /%[Y]/[X]:1. or change the HDCP compliance status to "on" from the web GUI.  |
|   | The display does not support the input resolution.  | Switch to another input source, or set the display to learn the EDID data setting of the input.     |
| Cannot control the Matrix Switch via the front panel buttons. | Front panel buttons are locked.   | Send the RS232 command /%Unlock; or select unlock from within the web GUI.                          |
| Cannot control the Matrix Switch via the IR remote.           | The IR remote batteries are too weak.   | Replace with new batteries.   |
|   | The IR remote is damaged.   | Send it to an authorized dealer to be repaired.   |
|   | The IR remote is too far from the IR sensor, or it is not being pointed correctly at the IR sensor. | Move the IR remote closer to the IR sensor, while pointing the IR remote directly at the IR sensor. |
|   | The IR sensor connected to the IR IN port does not  | Replace the IR sensor for one supporting carrier  |

|  |  |   |
|--|--|---|
|  | support carrier wave.  | wave.   |
| The power Indicator remains "off" when the unit is switched "on".    | Faulty or loose power connection.                                | Make sure there is a good connection.   |
| EDID management does not work normally.                              | The HDMI cable is damaged at the output end.                     | Replace the HDMI cable with a known good cable.   |
| The display is showing a blank screen when switching.                | The display does not support the resolution of the video source. | Try switching again.  |
|  |  | Manage the EDID data manually to ensure that the resolution of the video source is compatible with the output resolution. |
| Cannot control the Matrix Switch via RS232 (e.g. a PC.s RS232 port). | Wrong cable connection.  | Check the RS232 cable connectivity and pinout between the controlling device and the Matrix Switch.                       |
|  | Wrong RS232 communication parameters.                            | Ensure that the RS232 communication parameters are set to: Baud rate:9600; Data bit: 8; Stop bit: 1; Parity bit: none     |
|  | Damaged RS232 port.  | Send it to an authorized dealer for validation and repair.  |
| Static becomes stronger when connecting the video connectors.        | Bad grounding.   | Check the grounding, and ensure that it is well connected.  |
| Cannot control the device by RS232 / IR remote / front panel buttons | The device is damaged.   | Send unit to an authorized dealer for repair.   |

If you still cannot diagnose the problem, please call MuxLab Customer Technical Support at 877-689-5228 (toll-free in North America) or at (+1) 514-905-0588 (International).

## Regulatory Compliance

### Disclaimer

Information in this document is subject to change without notice. The manufacturer does not make any representations or warranties (implied or otherwise) regarding the accuracy and completeness of this document and shall in no event be liable for any loss of profit or any other commercial damage, including but not limited to special, incidental, consequential, or other damages.

No part of this document may be reproduced or transmitted in any form by any means, electronic or mechanical, including photocopying, recording or information recording and retrieval systems without the express written permission of the manufacturer.

All brand names and product names used in this document are trademarks, or registered trademarks of their respective holders.

## ***CE/FCC & Recycling Information***

---

### ***CE Certification***

This equipment complies with the requirements relating to Electromagnetic Compatibility Standards EN55022/EN55024 and the further Standards cited therein. It must be used with shielded cables only. It has been manufactured under the scope of RoHS compliance.

### ***FCC Certification***

This equipment has been tested and found to comply with the limits for a Class B digital device, pursuant to part 15 of the FCC Rules. These limits are designed to provide reasonable protection against harmful interference in a residential installation. You are cautioned that changes or modification not expressly approved by the party responsible for compliance could void your authority to operate the equipment.

This device complies with part 15 of the FCC Rules.

Operation is subject to the following two conditions:

1. This device may not cause harmful interference, and
2. This device must accept any interference received, including interference that may cause undesired operation



### ***WEEE (Waste of Electrical and Electronic Equipment), Recycling of Electronic Products***

In 2006 the European Union introduced regulations (WEEE) for the collection and recycling of all waste electrical and electronic equipment. It is no longer allowable to simply throw away electrical and electronic equipment. Instead, these products must enter the recycling process.

Each individual EU member state has implemented the WEEE regulations into national law in slightly different ways. Please follow your national law when you want to dispose of any electrical or electronic products. More details can be obtained from your national WEEE recycling agency.





8495 Dalton Road, Mount Royal, Quebec, Canada. H4T 1V5

Tel: (514) 905-0588

Fax: (514) 905-0589

Toll Free (North America): (877) 689-5228