

HDMI 4x4 Matrix Switch, HDBT

500416-POE-US

500416-POE-UK

500416-POE-EU



Installation Guide

P/N: 94-000750-A SE-000750-A

Copyright Notice:

Copyright © 2013 MuxLab Inc. All rights reserved.

Copyright © 2009 Real Time Engineers Ltd.

This product uses an unmodified version of FreeRTOS V6.0.0. Source code available at www.freertos.com

Printed in Canada. No part of this publication may be reproduced, stored in a retrieval system, or transmitted in any form or by any means, electronic, mechanical, photocopying, recording or otherwise without prior written permission of the author.

Trademarks:

MuxLab is a registered trademark of MuxLab Inc.

Table of Contents

1. Overview	4
1.1. Description	4
1.2. Features	5
2. Technical Specifications	6
3. Installation Procedure	7
3.1. Parts List	7
3.2. Product Overview	8
3.3. Pre-Installation Checklist	9
3.4. Physical Installation	10
3.5. Installation Procedure	11
3.6. Manual Control of Matrix Switch	14
3.7. Remote Control of Matrix Switch	15
3.8. Remote Control of Sources and Displays	16
3.9. EDID and DIP Switch Settings	17
3.10. Port Control Operation	18
3.11. USB Driver Setup	19
3.12. Ethernet Web Interface	22
4. Troubleshooting	32
5. Appendix	33
A. ASCII Command Set	33
B. IP Control Commands	46
C. Infrared Remote Control Codes	51
6. Product Warranty Policy	52

1. Overview

1.1. Description

The MuxLab HDMI 4x4 Matrix Switch, HDBT (500416-POE) allows 4 HDMI sources to be switched/distributed to up to 4 remote displays via unshielded twisted pair (UTP) or shielded twisted pair (STP) cables for cost-efficient connectivity. Remote displays can be connected up to 230 feet (70 meters) @ 1080p Deep Color via Cat 5e/6 UTP/STP cables. The Matrix Switch works in conjunction with MuxLab's HDMI Receiver (500454-RX or 500454-POE-RX).

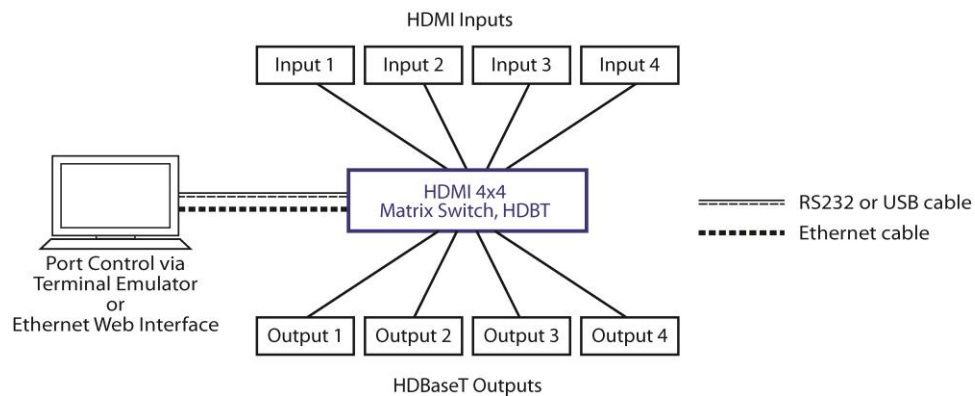

Figure 1: System Overview

Applications include commercial and residential AV systems, classroom projector systems, digital signage, boardroom systems, multi-room systems, classroom training, retail systems, collaborative PC systems, and medical information systems.

1.2. Features

- Single modular RJ45 jacks
- UTP/STP extension for 1080p Deep Color up to 230 feet (70 meters) via Cat 5e/6 UTP/STP cables
- HDMI 3D support
- Seamless integration with MuxLab's HDMI Receiver (500454-RX or 500454-POE-RX)
- HDMI input supported with resolution up to 1080p
- HDBaseT supported output
- Configurable EDID settings
- Web interface
- RS232 and USB CDC control
- Firmware is field upgradable
- Switches for manual control
- Device control over HTTP protocol
- 1U rackmount unit

2.

Technical Specifications

4x4 Matrix Switch, HDBT Chassis	
Environment	HDMI 1.4A 3D Support
Devices	LCD and Plasma TVs, DVD and Blu-Ray players, monitors, projectors, PCs, laptops, home theatre systems, home theater PCs, game consoles.
Transmission	Transparent to the user
Input	Four (4) HDMI and four (4) IR Sensor (3.5 mm stereo)
Output	Four (4) HDBaseT (RJ45) and four (4) IR Emitter (3.5 mm mono)
Connectivity	Ethernet LAN (RJ45), USB (Type B) and RS232 (DB9)
Maximum Distance	UTP/STP Cat 5e/6 output port: 230 feet (70 meters)
Cables	Cat 5e/6 UTP/STP cables (or better) required for HDBaseT port
Power	24 VDC, 5A
Matrix Switching Time	3 seconds (maximum)
LED Diagnostics	Power (Blue) Connections Status (Green) LAN (Link (Green) and Activity (Yellow))
Temperature	Operating: 0°C to 40°C Storage: -20°C to 85°C Humidity: Up to 95% non-condensing
Dimensions	1U Rack Mountable: 16.9 x 8.7 x 1.8 in (43.0 x 22.0 x 4.5 cm)
Accessories Included	4 IR Sensors, 4 IR Emitters, Remote, USB Cable, RS232 Cable
Shipping Weight	10 lb (4.5 kg)
Regulatory	FCC, CE, RoHS, WEEE
Warranty	Two (2) years
Order Information	500416-POE-US (UPC: 627699014165) HDMI 4x4 Matrix Switch, HDBT 500416-POE-UK (UPC: 627699914168) HDMI 4x4 Matrix Switch, HDBT 500416-POE-EU (UPC: 627699814161) HDMI 4x4 Matrix Switch, HDBT

Table 1: Technical Specifications

3. **Installation Procedure**

3.1. Parts List

The HDMI 4x4 Matrix Switch, HDBT (500416-POE) comes with the following parts:

- Base unit
- Four (4) IR Emitters
- One (1) IR Sensors
- One (1) 110-240V/24VDC, 5A Power Supply
- Power Cord (US, EU or UK)
- One (1) USB Type A - Type B Cable
- One (1) RS232 Cable
- One (1) Infrared remote
- One (1) Quick Reference Sheet

Please verify that all parts are present before proceeding.

3.2. Product Overview

The external connections and connection indicators of the HDMI 4x4 Matrix Switch are detailed in Figure 2 and Figure 3 (mounting brackets not shown). Please familiarize yourself with them before installing the unit.

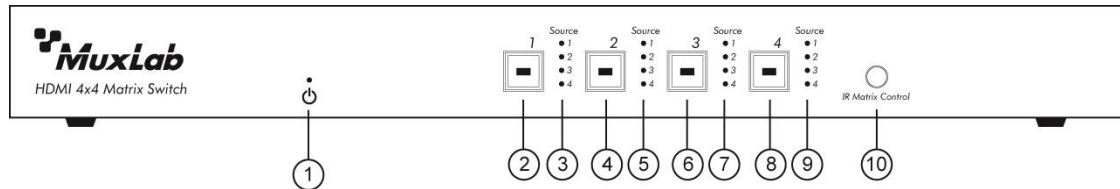

Figure 2: Front Panel

Front Panel Legend

1. Power indicator (blue LED)
2. Display 1 pushbutton (blue LED)
3. Source selection indicators for display 1 (green LEDs)
4. Display 2 pushbutton (blue LED)
5. Source selection indicators for display 2 (green LEDs)
6. Display 3 pushbutton (blue LED)
7. Source selection indicators for display 3 (green LEDs)
8. Display 4 pushbutton (blue LED)
9. Source selection indicators for display 4 (green LEDs)
10. Sensor for Matrix Switch remote

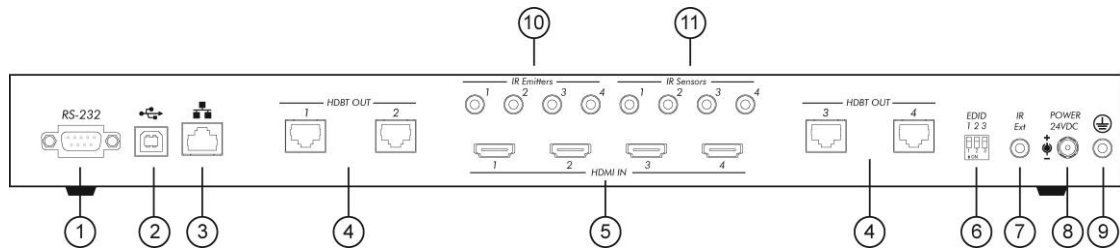

Figure 3: Back Panel

Back Panel Legend

1. RS-232 Port
2. USB Port
3. LAN Port (RJ45)
4. HDBT OUT ports (RJ45)
5. HDMI IN ports
6. DIP switch for EDID
7. 3.5 MM port for IR extender cable
8. Power Supply port
9. Ground Port
10. 3.5 MM ports for IR emitter cables
11. 3.5 MM ports for IR sensor cables

3.3. Pre-Installation Checklist

The HDMI 4x4 Matrix Switch, HDBT provides a centralized HDMI switching center via UTP/STP cables.

1. The Matrix Switch is used in conjunction with MuxLab's UTP/STP HDMI Receiver (500454-RX or 500454-POE-RX).
2. The Matrix Switch is typically installed in a remote telecom room and is connected to multiple video sources and display devices via Cat 5e/6 UTP/STP or HDMI cables. A MuxLab Receiver is installed at each display to support the connection to the Matrix Switch via a Cat 5e/6 cable.

3.4. Physical Installation

MuxLab's HDMI 4x4 Matrix Switch, HDBT comes with mounting brackets for standard 19" rack mounting. Select the final destination for the product and install the unit using standard rack-mount screws (Figure 4).

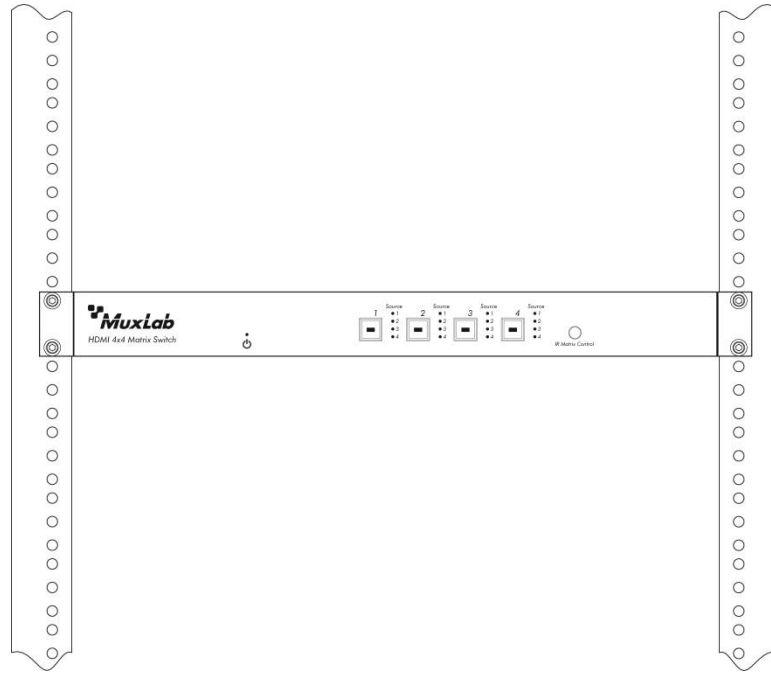

Figure 4: Setup for Rackmount Installation

For set-top installation, the side mounting brackets may be removed, and the included rubber feet placed on the bottom of the unit. When removing the mounting brackets, be careful to keep and reinstall the four screws on each side of the unit (Figure 5).

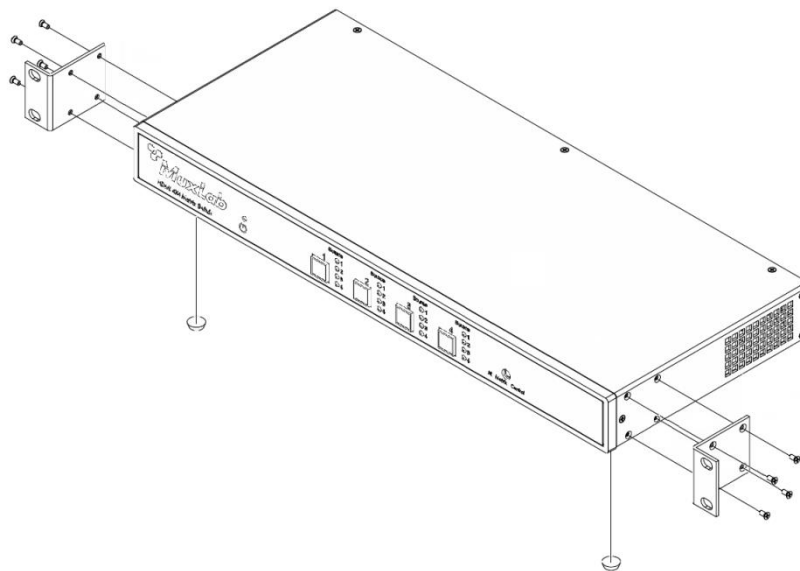

Figure 5: Setup for Set-top Installation

3.5. Installation Procedure

In order to install the HDMI 4x4 Matrix Switch, HDBT, please follow the steps below:

1. Place the Matrix Switch in its final location (see Section 3.4 Physical Installation).
2. Ensure that power is OFF on all sources and displays.
3. Using HDMI cables (not included), connect each source to an *HDMI IN* port on the back panel of the Matrix Switch.
4. Ensure that one MuxLab Receiver is connected to each display using an HDMI cable (not included). For more information, refer to MuxLab's *500454 Quick Installation Guide*.
5. Using Cat 5e/6 UTP/STP cables (not included), connect each MuxLab Receiver to an *HDBT OUT* port on the back panel of the Matrix Switch.
6. OPTIONAL:
 - Using an RS232 or USB cable, connect a computer to the corresponding port on the back panel of the Matrix Switch.
 - Using an Ethernet cable, connect the Matrix Switch to the local area network.
 - Connect an RS232 cable (not included) between the RS232 port on the MuxLab Receiver and the RS232 port on the display.
 - Connect IR sensors and emitters as needed. For more information, refer to Figures 5 and 6. NOTE: IR Sensor cables are equipped with a 3.5 mm stereo jack, and IR Emitter cables are equipped with a 3.5 mm mono jack.
7. Power up MuxLab Receivers and HDMI equipment.
8. Connect the external 24VDC power supply to the Matrix Switch and plug the power supply into an AC power outlet. If power is present, the blue power LED will be illuminated.
9. Ensure that the source and appropriate display LEDs are ON. Images should appear on the displays within 10 seconds. For signal or image quality problems, refer to Section 4 Troubleshooting.
10. Figures 6 and 7 show some typical configurations.

The Matrix Switch is now ready to use. See Section 3.7 Manual Control for instructions on usage.

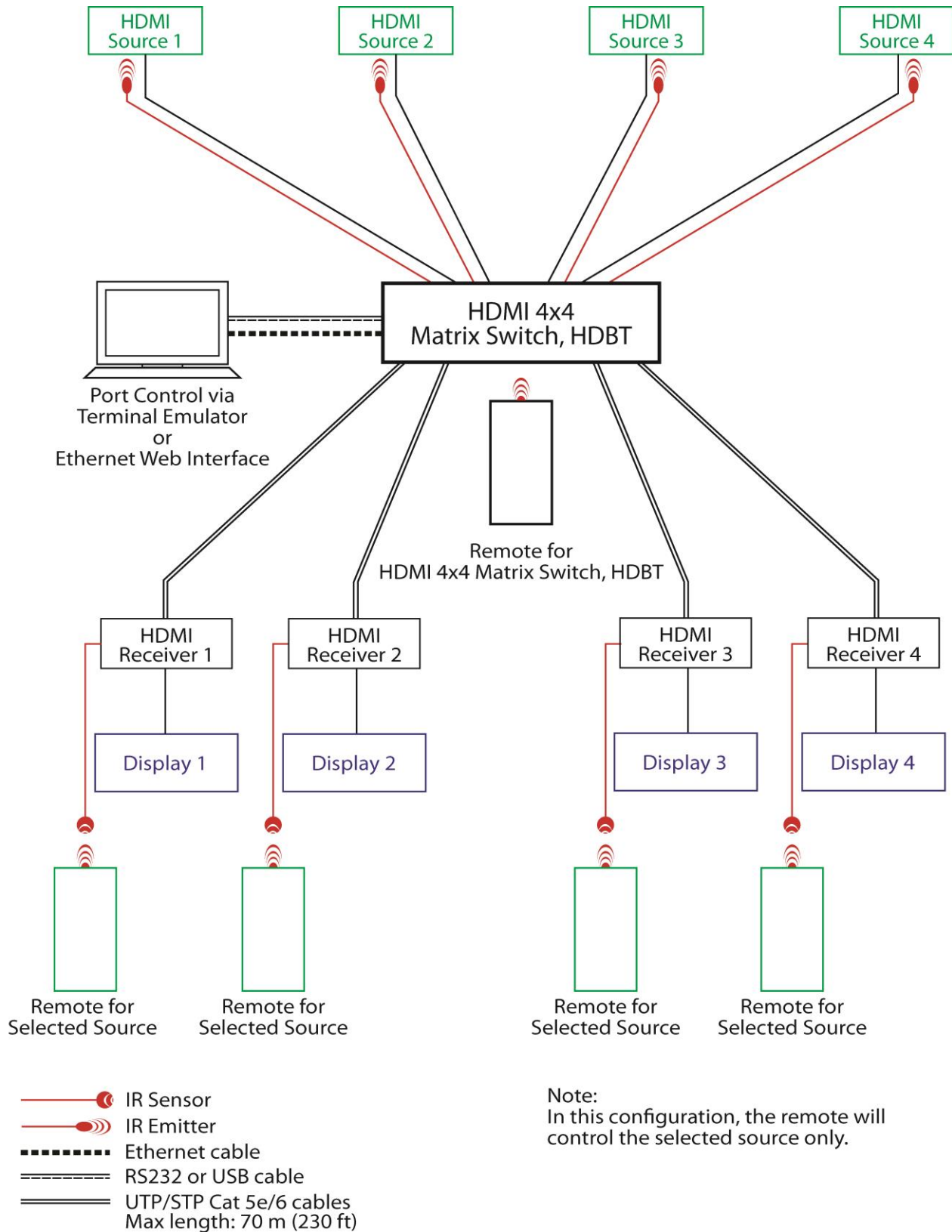
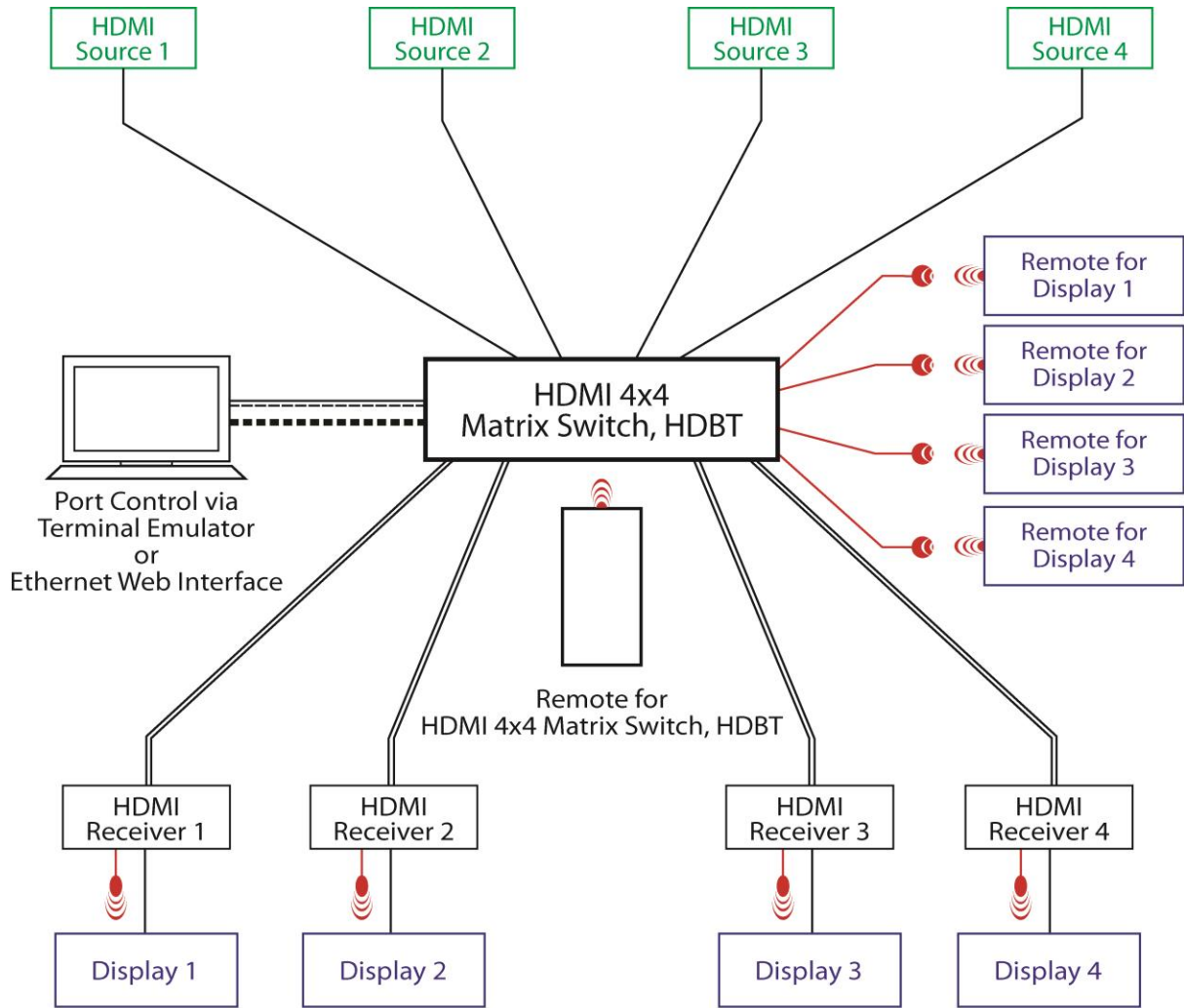







Figure 6: Typical Configuration (I)



-  IR Sensor
-  IR Emitter
-  Ethernet cable
-  RS232 or USB cable
-  UTP/STP Cat 5e/6 cables
Max length: 70 m (230 ft)

Note:
In this configuration, the remote will control one display only (fixed configuration).

Figure 7: Typical Configuration (II)

3.6. Manual Control of Matrix Switch

The HDMI 4x4 Matrix Switch, HDBT may be manually controlled by using pushbuttons on its front panel (Figure 8).

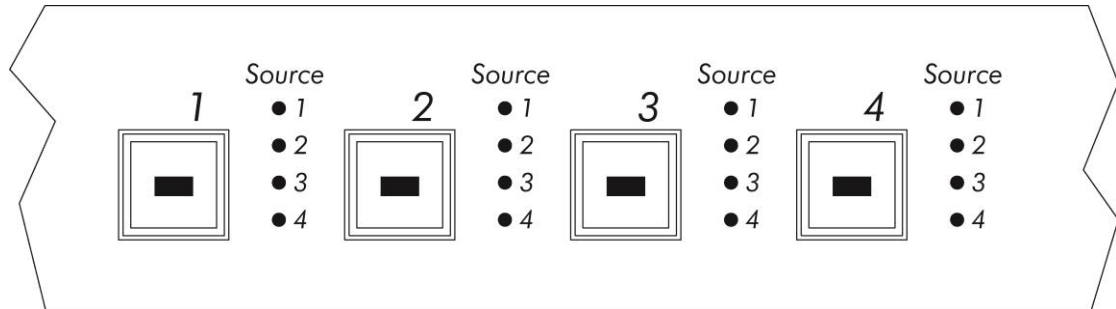

Figure 8: Front Panel Controls

There are four controls on the front panel of the Matrix Switch. Each control consists of a square pushbutton that is continuously illuminated by a blue LED when the Matrix Switch is powered. Each pushbutton corresponds to a display of the same number (1 through 4):

- Pushbutton 1: Display connected to Matrix Switch *HDBT OUT 1* port (via Receiver)
- Pushbutton 2: Display connected to Matrix Switch *HDBT OUT 2* port (via Receiver)
- Pushbutton 3: Display connected to Matrix Switch *HDBT OUT 3* port (via Receiver)
- Pushbutton 4: Display connected to Matrix Switch *HDBT OUT 4* port (via Receiver)

Next to each pushbutton are four small LEDs (“Source LED”), which illuminate green to indicate which source is selected for a given display. Each Source LED corresponds to a source of the same number (1 through 4):

- Source LED 1: Source connected to Matrix Switch *HDMI IN 1* port
- Source LED 2: Source connected to Matrix Switch *HDMI IN 2* port
- Source LED 3: Source connected to Matrix Switch *HDMI IN 3* port
- Source LED 4: Source connected to Matrix Switch *HDMI IN 4* port

By pressing a given pushbutton, the user selects which source to transmit to the display corresponding to that pushbutton.

3.7. Remote Control of Matrix Switch

The Matrix Switch can be controlled by a remote (Figure 9). The remote is divided into 4 sections, with each section controlling a particular display. For any given display, the user can choose which source to send to that display, either directly by clicking on buttons 1, 2, 3, or 4, or indirectly by pressing on the ◀ or ▶ buttons to cycle through the sources.

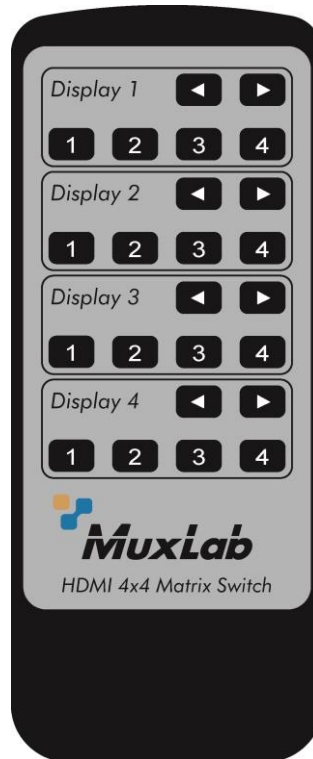

Figure 9: Remote

To use the remote, the user must physically aim it at the front panel of the Matrix Switch, which contains an IR sensor to receive line-of-sight signals from the remote. An optional IR extender cable (500999, not included) can be connected to the *IR Ext* port on the rear panel of the Matrix Switch. The free end of the IR extender cable contains an IR sensor that can be placed up to 117 centimeters (46 inches) from the Matrix Switch, offering greater flexibility in using the remote.

The remote can also control the Matrix Switch at display locations via MuxLab receivers. To do this, the user aims the remote at the receiver's IR sensor and sends command signals to the Matrix Switch. The receiver then transmits these signals to the Matrix Switch via the UTP/STP cables connecting the receiver to the Matrix Switch. **To initiate this function, the user must simultaneously press square pushbuttons 2 and 4 on the front panel of the Matrix Switch for approximately 3 seconds.** At that point, all the Source LEDs will flash once to indicate that the remote can now be used at display locations. To disable this function, the user must simultaneously press the same pushbuttons for approximately 3 seconds. All the Source LEDs will flash twice to indicate that the remote cannot be used at display locations.

3.8. Remote Control of Sources and Displays

Sources and displays do not have to be controlled at their physical location. Using MuxLab receivers, each source and display can be controlled at different locations using their respective remotes.

Using source remotes, sources can be controlled at display locations via receivers (see Figure 6). To do so, make sure that the IR emitter cable leading from the *IR Emitters* port 1 on the back of the Matrix Switch has its emitter end placed in front of IR sensor on source 1. Do the same for all ports and all sources (see Table 3).

Matrix Switch – <i>IR Emitters</i> Port	IR Emitter Cable	Sensor on Source
1	Jack End ----- Emitter End	1
2	Jack End ----- Emitter End	2
3	Jack End ----- Emitter End	3
4	Jack End ----- Emitter End	4

Table 3: Source Remote Control Configuration

Using display remotes, displays can be controlled at the Matrix Switch location via receivers (see Figure 7). To do so, make sure that the remote of display 1 is directed at the sensor end of the IR sensor cable leading from the *IR Sensors* port 1 on the back of the Matrix Switch. Do the same for all ports and display remotes (see Table 4).

Matrix Switch – <i>IR Sensors</i> Port	IR Sensor Cable	Display Remote
1	Jack End ----- Sensor End	1
2	Jack End ----- Sensor End	2
3	Jack End ----- Sensor End	3
4	Jack End ----- Sensor End	4

Table 4: Display Remote Control Configuration

3.9. EDID and DIP Switch Settings

Every digital display has extended display identification data (EDID) that describes its capabilities to a video source. This enables the source to know which type of display is connected to it, and to send compatible signals to that display.

The EDID settings of any display can be relayed to any source by means of a DIP switch located on the back panel of the Matrix Switch (Figure 10). The DIP switch has three contacts (1, 2, 3), each of which can either be set up (OFF) or down (ON).

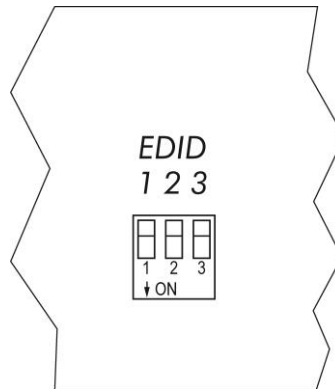

Figure 10: EDID DIP Switch (Back Panel)

Various DIP switch settings enable the user to relay any display's EDID to any source. Table 5 shows 8 pre-defined DIP switch settings and the function of each.

Contact 1	Contact 2	Contact 3	Function
OFF	OFF	OFF	Variable EDID: Relays EDID of display to selected source ¹
OFF	OFF	ON	Fixed EDID: 1080p 3D stereo ²
OFF	ON	OFF	Fixed EDID: 1080p stereo ²
OFF	ON	ON	Fixed EDID: 1080i stereo ²
ON	OFF	OFF	Fixed EDID: 1080p 5.1 ²
ON	OFF	ON	Fixed EDID: 1080P 7.1 ²
ON	ON	OFF	[Reserved]
ON	ON	ON	[Reserved]

Table 5: DIP Switch Settings

Notes:

1. To relay the EDID of display *x* to source *y*, the user must first ensure that source *y* is currently selected for display *x*. The user then presses on the square pushbutton of display *x* (located on the front panel of the Matrix Switch) for 3 seconds. The EDID of display *x* has now been relayed to source *y*.

Example: To relay the EDID of display 4 to source 1, first ensure that display 4 is currently selecting source 1. Next, press on the square pushbutton of display 4 for 3 seconds. The EDID of display 4 has now been relayed to source 1.

2. Selected fixed EDID will be active only after a power cycle of the Matrix Switch.

3.10. Port Control Operation

MuxLab's 4x4 Matrix Switch, HDBT may be controlled in the following two ways:

1. RS-232 Control
2. USB CDC Control

1. RS-232 Control

The Matrix Switch features built-in firmware that allows commands from an ASCII terminal to be sent directly to the device via an RS-232 connection. Ensure that the RS-232 cable has the straight-through configuration shown in Figure 11.

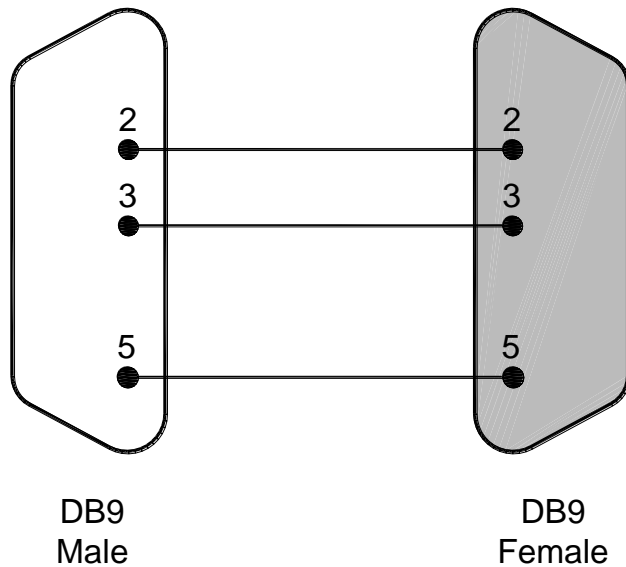

Figure 11: RS-232 Cable Configuration

Please note that the use of USB to RS232 converter cables may result in problems, depending on the quality of the converters.

2. USB CDC Control

Commands from an ASCII terminal may also be sent directly to the device via a USB connection. Maintenance can be performed with a terminal emulator, such as the one available under windows with the ASCII Command set described in the Appendix of this manual.

3.11. USB Driver Setup

When interfacing a MuxLab device with the USB port on Windows XP, Windows 7, or Windows 8 operating systems, a driver setup file will be required. For Linux and Mac OS X operating systems, no driver is necessary.

To install the USB serial driver, download the SC-000032-A USB to serial driver file from the MuxLab website and save it to the local hard drive. NOTE: If the downloaded file is compressed, it will have to be uncompressed before using it.

Plug the USB cable between the device and the PC, and power up the device. The **Found New Hardware** wizard will open (Figure 12). Select **Locate and install driver software (recommended)**.



Figure 12: Found New Hardware Wizard

A new dialog box will open (Figure 13). Select **B**rowse my computer for driver software (advanced).

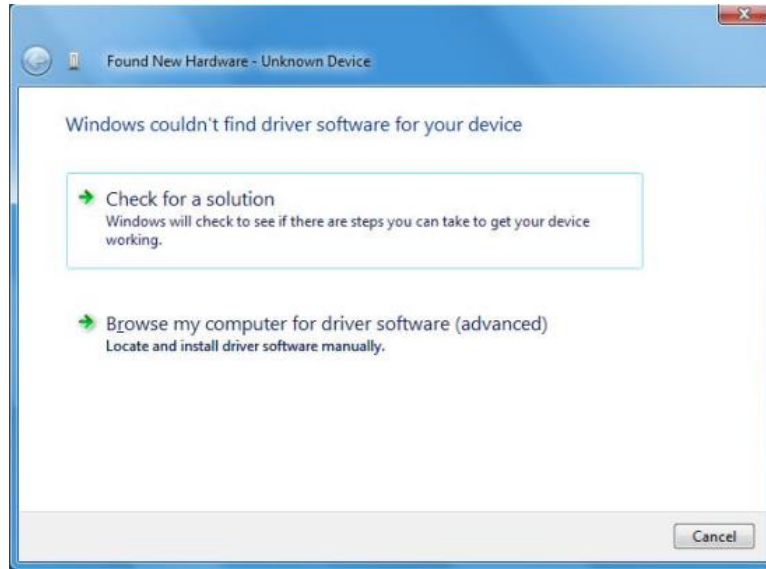

Figure 13: Found New Hardware Dialog Box

Another dialog box will open (Figure 14). Click **B**rowse and locate the SC-000032-A USB to serial driver file downloaded earlier. Once found, click **N**ext.

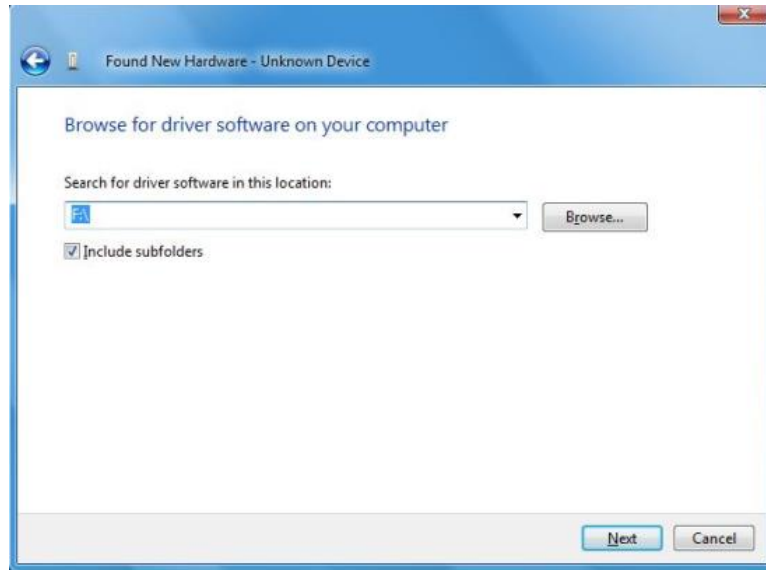

Figure 14: Browsing for Unknown Device

A security window will now appear, indicating that the driver software is unsigned (Figure 15). Select **Install this driver software anyway**.



Figure 15: Windows Security

A window will appear instructing that the software for the driver has been successfully installed (Figure 16). Click **Close**.

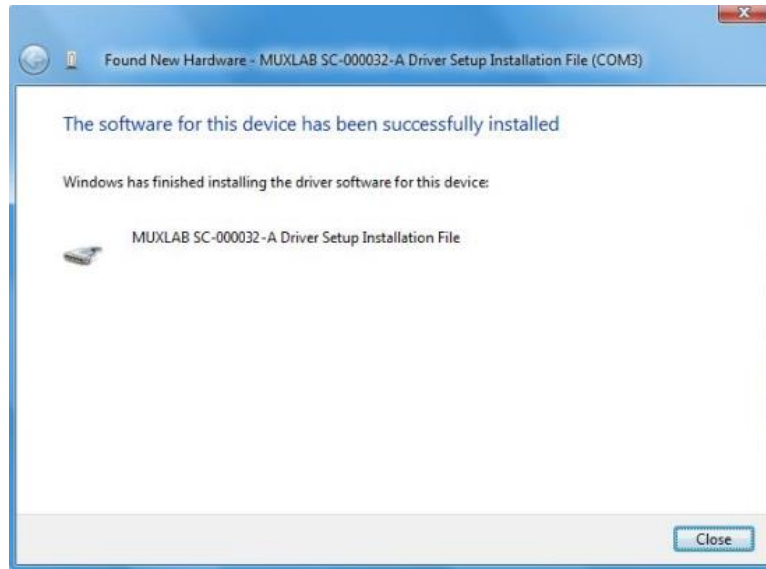

Figure 16: Successful Installation Dialog Box

3.12. Ethernet Web Interface

MuxLab offers users an Ethernet Web interface that provides the same functionality as manual control, with speeds of 10 Mbps or 100 Mbps.

To use the Ethernet Web interface, the Matrix Switch must first be physically connected to an Ethernet network. To do this, locate the RJ45 Ethernet jack on the back panel of the Matrix Switch, then connect it to an Ethernet network using a straight UTP cable (maximum length: 328 feet [100 meters]). There are two LEDs at the bottom of the RJ45 Ethernet jack: A green LED will go on if a link is detected, and a yellow LED will blink if Ethernet activity is detected.

Once the Matrix Switch has been physically connected to an Ethernet network, go to <http://AAA.BBB.CCC.DDD>, where AAA.BBB.CCC.DDD is the device IP address. (NOTE: The device IP address can be obtained by pressing the Info button on the front panel.)

The **Login** screen is the first screen to appear (Figure 17).

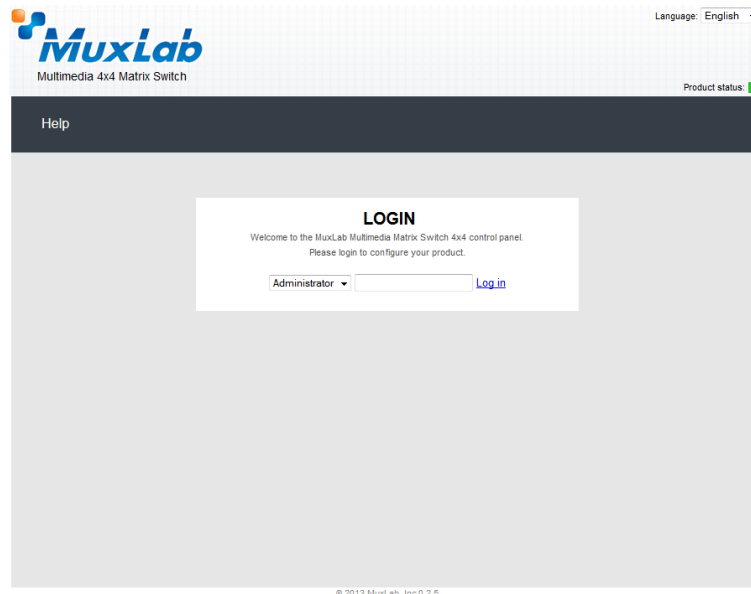

Figure 17: Ethernet Web Interface Login Screen

The default password for administrators is **admin**. The default password for regular users is **user**.

NOTE: Users who have previously logged in and chosen a password, but have subsequently forgotten it, may connect to the device using the RS232 or USB and reset their password using a terminal emulator.

Three items are presented to the user at the top right of every Ethernet Web interface screen:

- Logout option
- Language option
- Product status

The **Logout** hyperlink logs the user out of the system.

The **Language** drop-down list provides the user with three interface languages: English, French, and Spanish. English is used by default.

The **Product status** indicator provides a quick indication of device status by means of a colored box (green, orange, red) to indicate various product statuses:

- Green = Okay
- Orange = Warning
- Red = Error

The user can configure the **Product status** indicator to display different statuses depending on various device conditions (internal temperature, fan speed, etc.). This configuration is performed in the **Alarm** tab of the **Setup** submenu.

After logging in, the main screen appears (Figure 18). It contains three submenus:

- (1) Port Management
- (2) Setup
- (3) Help

(1) Port Management

The **Port Management** submenu (Figure 18) appears after the user has successfully logged in.

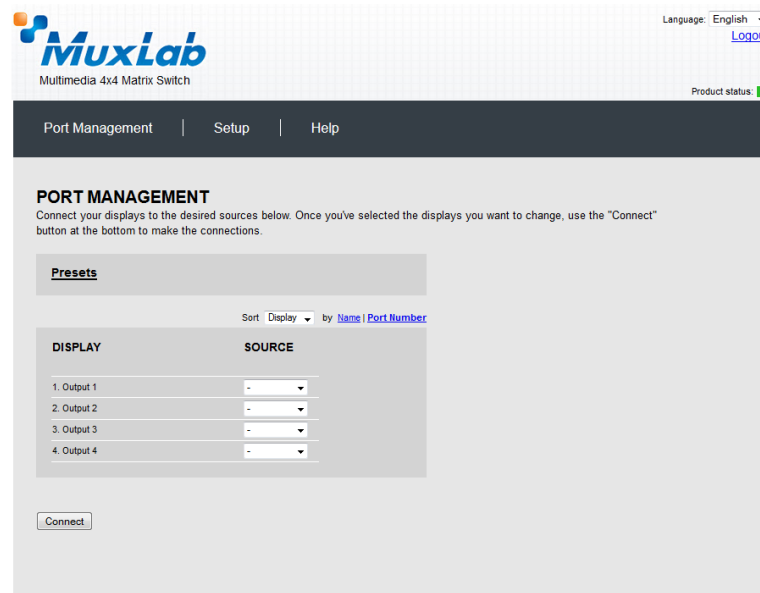

Figure 18: Port Management Submenu

The **Port Management** submenu manages the connection configurations of displays and sources.

A connection configuration is a specific set of mapping instructions between all displays and devices. A saved connection configuration is known as a preset.

The **Port Management** submenu allows the user to make individual connections between specific displays and sources, or wholesale connections between all displays and sources by means of presets. Sources and displays are presented to the user in any one of four ways:

- By source name
- By source number
- By display name
- By display number

Figure 19 illustrates sources and displays presented by display number. The user can make changes to the connection configuration of the device by selecting any option in the drop-down boxes in the **Source** column. Once any change is made, the given row will change color to indicate that a change has taken place. Once all selections have been made, the user clicks on the **Connect** button to apply those selections.

Presets are pre-established connection configurations that are used to apply wholesale mapping instructions between all displays and sources (see Figure 19). The user can load any one of eight presets to the device. Once a preset is selected from the **Preset** drop-down menu, the user clicks on **Load Preset** to show the connection configuration of the given preset. To apply the preset, the user clicks on **Make Connections**.

To modify a given preset, its name must first appear in the **Preset** drop-down menu. The user then makes changes to the connections between displays and sources (any change will result in a highlighted row). Once all changes are made, the user clicks on **Save Preset**. This effectively modifies the connection configuration of the given preset.

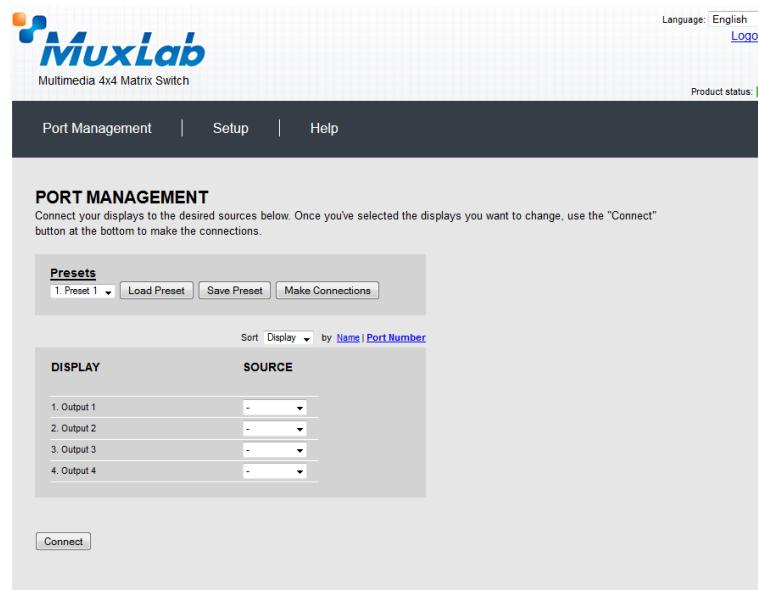
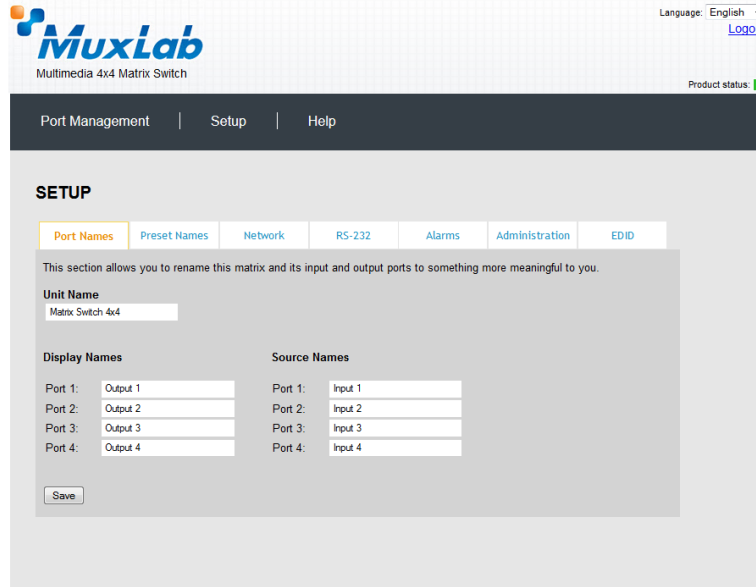

Figure 19: Port Management Submenu – Presets

(2) Setup

The **Setup** submenu (Figure 20) is used to perform the following tasks:

- Modify port names
- Modify present names
- Modify network connections and passwords
- Modify RS232 connections
- Modify alarm settings
- Upgrade firmware



The screenshot shows the MuxLab Multimedia 4x4 Matrix Switch web interface. The top navigation bar includes 'Port Management', 'Setup', and 'Help'. The 'Setup' submenu is active, with tabs for 'Port Names', 'Preset Names', 'Network', 'RS-232', 'Alarms', 'Administration', and 'EDID'. The 'Port Names' tab is selected. The main content area contains a 'Unit Name' field with the value 'Matrix Switch 4x4'. Below this are two columns of input fields: 'Display Names' and 'Source Names'. Each column has four rows, labeled 'Port 1' through 'Port 4'. The 'Display Names' column has 'Output 1' through 'Output 4' and the 'Source Names' column has 'Input 1' through 'Input 4'. A 'Save' button is located at the bottom left of the form area.

Figure 20: Setup Submenu – Port Names Tab

In the **Port Names** tab, the user can modify port names in the **Display Names** and **Source Names** columns, and then click on **Save** to save these modifications. The user can also modify the name of the entire device by changing the text that appears in the **Unit Name** box and clicking on **Save**.

The length of all names is limited to 20 characters each.

In the **Preset Names** tab (Figure 21), the user can modify the names of presets.

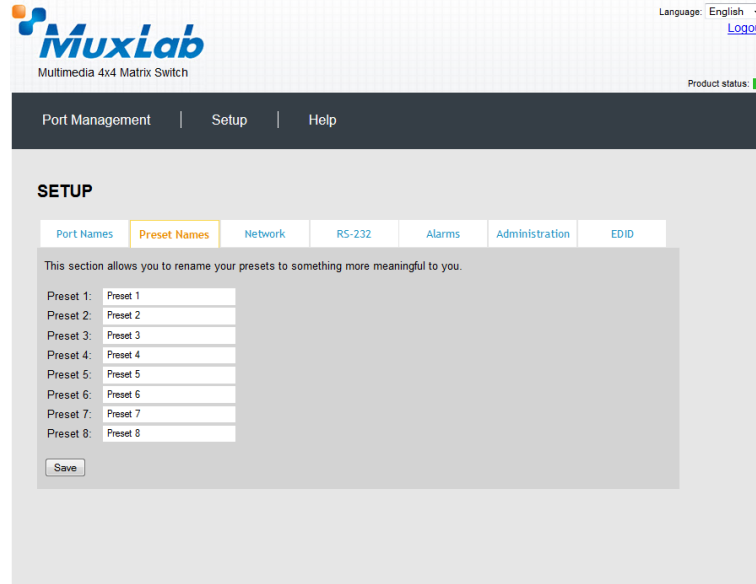

The screenshot shows the MuxLab Multimedia 4x4 Matrix Switch web interface. The top navigation bar includes 'Port Management', 'Setup', and 'Help'. The 'Setup' section is active, and the 'Preset Names' tab is selected. The interface displays a list of eight presets, each with a text input field for renaming. A 'Save' button is located at the bottom left of the form. The page also features a language dropdown set to 'English', a 'Logout' link, and a 'Product status' indicator.

Figure 21: Setup Submenu – Preset Names Tab

After preset names are modified, the user clicks on **Save** to save these modifications.

The length of preset names is limited to 20 characters each.

In the **Network** tab (Figure 22), the user can modify network settings and passwords for users and (if applicable) administrators.

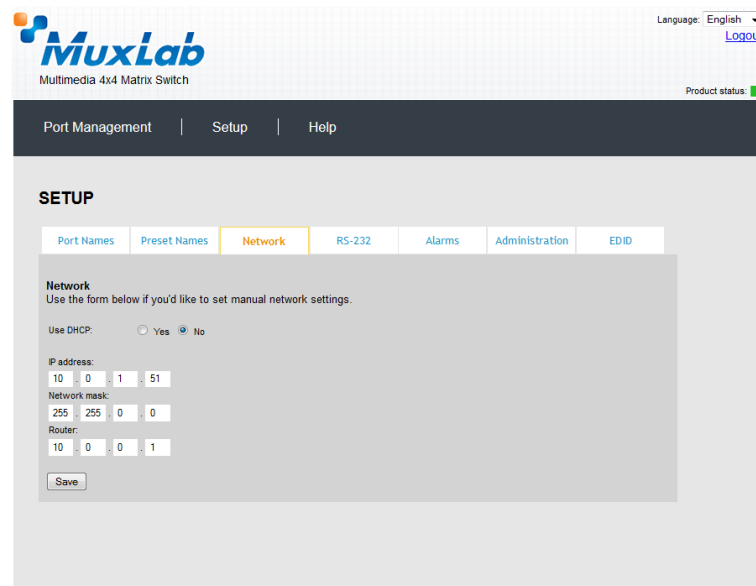

The screenshot shows the MuxLab Multimedia 4x4 Matrix Switch web interface. The top navigation bar includes 'Port Management', 'Setup', and 'Help'. The 'Setup' section is active, and the 'Network' tab is selected. The interface displays a form for manual network settings, including radio buttons for 'Use DHCP' (Yes/No), and input fields for 'IP address', 'Network mask', and 'Router'. A 'Save' button is located at the bottom left of the form. The page also features a language dropdown set to 'English', a 'Logout' link, and a 'Product status' indicator.

Figure 22: Setup Submenu – Network Tab

To implement network modifications, the user makes changes to the **IP address**, **Network mask**, or **Router** fields and then clicks on **Save**. The user also has the option of using DHCP.

To implement password modifications, an administrator makes changes to the **Administrator Password** and/or the **User Password**, and then clicks on the corresponding **Save** button. Regular users can only make changes to the **User Password**.

In the **RS-232** tab (Figure 23), the user can modify RS-232 settings.

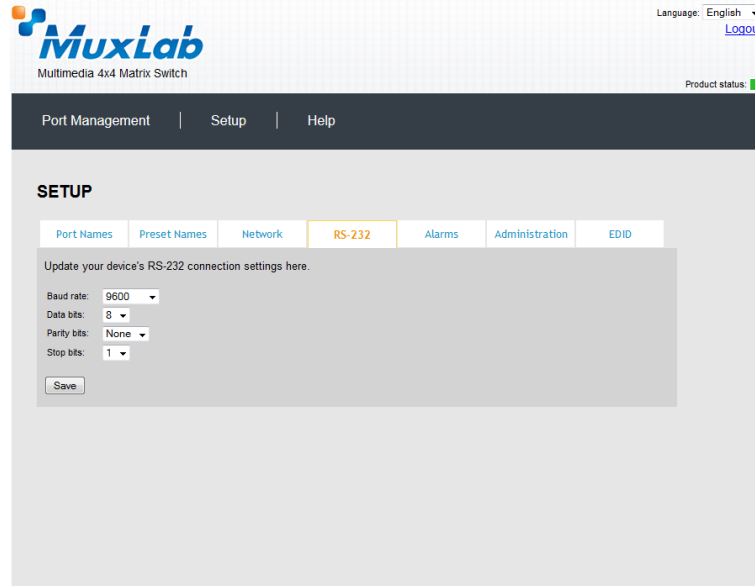

Figure 23: Setup Submenu – RS-232 Tab

To implement RS-232 modifications, the user selects options in the drop-down boxes for **Baud rate**, **Data bits**, **Parity bits**, or **Stop bits** and then clicks on **Save**.

In the **Alarms** tab (Figure 24), the user can modify the settings that dictate when an alarm will be triggered.

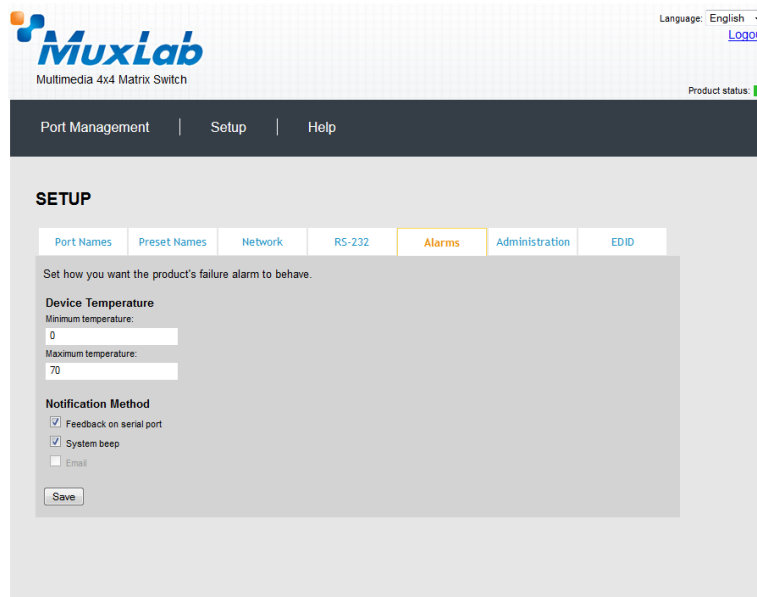

Figure 24: Setup Submenu – Alarms Tab

Minimum and maximum temperatures are understood to be in degrees Celsius (°C). Once all modifications have been made, the user clicks on **Save**.

In the **Administration** tab (Figure 25), the user can modify passwords for users and (if applicable) administrators, select and install new firmware, restore or backup data and reset the unit to factory settings.

The screenshot displays the MuxLab web interface for a Multimedia 4x4 Matrix Switch. The top navigation bar includes 'Port Management', 'Setup', and 'Help'. The 'Setup' menu is expanded, showing sub-menus: 'Port Names', 'Preset Names', 'Network', 'RS-232', 'Alarms', 'Administration' (highlighted), and 'EDID'. The 'Administration' sub-menu contains the following sections:

- Passwords:** A section for changing passwords. It includes a 'Current Administrator password' field and two columns for 'Administrator Password' and 'User Password', each with 'New password' and 'Confirm new password' fields. 'Save' buttons are provided for each.
- Firmware Upgrade:** A section for updating the device's firmware. It includes a 'Specify file:' field with a 'Parcourir...' button and an 'Upload' button.
- Restore data:** A section for restoring the unit with a selected data file. It includes a 'Specify file:' field with a 'Parcourir...' button and a 'Restore' button.
- Backup data:** A section for backing up the data and saving it in a file. It includes a 'Backup' button.
- Reset to factory settings:** A section for resetting the unit and applying the factory settings. It includes a 'Reset' button.

Figure 25: Setup Submenu – Administration Tab

To implement password modifications, an administrator makes changes to the **Administrator Password** and/or the **User Password**, and then clicks on the corresponding **Save** button. Regular users can only make changes to the **User Password**.

The file for upgrading the firmware must be located on the PC. The user clicks on **Choose File** to browse for the file, and then installs it by clicking on **Upload**.

It is recommended, before upgrading to a new firmware to do a **Backup** of all the data configurations, such as port names, presets, alarms, network settings etc. And then **Restore** these data after the firmware upgrade.

To do so, click on the “**Backup**” button and you will be asked to save the data configuration file. Then perform the firmware upgrade. After the unit is upgraded, go to the Administration tab, in the “Restore data” section, select the data configuration file previously saved on you PC, then click on the “Restore” button.

Finally, you can reset the unit and apply all the factory settings by clicking on the “Reset” button.

In the EDID tab (Figure 26), the user can apply pre-defined EDID settings to all input sources or apply EDID setting from any display to a given source.



Figure 26: Setup Submenu – EDID Tab

(3) Help

The **Help** submenu (Figure 27) provides the user with contact and support information.



Figure 27: Help Submenu

In addition to three submenu screens, the Ethernet web interface also provides the user with a detailed **Hardware Monitor** screen (Figure 28).

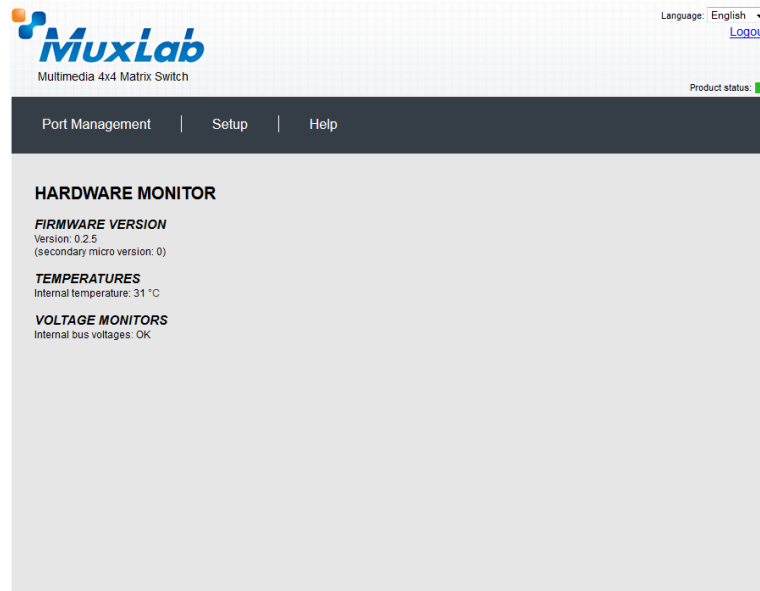

Figure 28: Hardware Monitor Screen

This screen can be accessed by clicking on the **Product status** link at the top right of any Ethernet web interface screen.

4. Troubleshooting

Table 6 lists common problems that affect image quality, as well as their possible causes and solutions. If the information below does not solve the problem, the technical support contact information can be found at the end of this section.

PROBLEM	POSSIBLE SOLUTIONS
No Image	Check the matrix connection status
No Image	Verify that the cables are properly connected
No Image	Verify that the source devices are powered up.
No Image	Verify that the source resolution is 1080p or less.
No Image	Verify that the display supports HDCP.
White Dots in image Flickering Image Choppy Sound	If using an extender, verify that the distance is less than 230 feet (70 meters) for UTP/STP.
Wrong Image Appears	Check matrix connection
Not All Display Devices Work	Check that the display supports the source resolution.

Table 6: Troubleshooting

When contacting your nearest MuxLab dealer or MuxLab Technical Support at 877-689-5228 (toll free in North America) or (+1) 514-905-0588 (International), please have the following information ready:

- Unit model number.
- Cabling layout. Please include the model of the HDMI source and receiver, cable length and type.
- Description of problem.
- List of tests performed.

5. Appendix

A. ASCII Command Set

Ensure that the terminal emulation program parameters are set to the following:

BAUD Rate:	9600
Data bits:	8
Stop bits:	1
Parity:	None
Flow control:	None

It should be noted that commands are case sensitive and arguments must be separated by a single space. Commands must be entered in the following way and ended with a carriage return.

Serial/USB Port Commands

1. Alarm

alarm

Description: Display all the alarm settings

Arguments: <none>

Example: alarm

Response: **Device Temperatures (Celsius):**

- Temp min: 0

- Temp max: 70

Notification Method:

- Beep: ON

- Serial Port: ON

- Email: OFF

(or an error message if the command failed)

alarm -t <min value> <max value>

Description: Set the minimum and maximum temperatures value before an alarm is raised

Arguments: <min value>: 0 to 150
<max value>: 0 to 150

Example: Set the minimum and maximum temperature to respectively 5 and 70 degree Celsius, before an alarm is raised

alarm -t 5 70

Response: **Minimum and Maximum temperatures applied successfully!**

(or an error message if the command failed)

alarm -n <method id> <state>

Description: Enable/disable a notification method.

Arguments: <method id>: b (beep), s (serial) or all
<state>: on or off

Example: Disable the beep notification method

alarm -n b off

Response: **Alarm notifications applied successfully!**

(or an error message if the command failed)

2. Connection

connect -i <input port #> **-o** <output port #>

Description: Connect a specific input to a specific output

Arguments: <input port #>: 1 to 4
<output port #>: 1 to 4

Example: Connect input 2 to output 4

connect -i 2 -o 4

Response: **[0,0,0,2]**
(or an error message if the command failed)

connect -i <input port #> **-o all**

Description: Connect a specific input to all outputs

Arguments: <input port #>: 1 to 4

Example: Connect input 2 to all outputs

connect -i 2 -o all

Response: **[2,2,2,2]**
(or an error message if the command failed)

connect -i <input port #> **-o** <from output port #>..**<to output port #>**

Description: Connect a specific input to a consecutive range of outputs

Arguments: <input port #>: 1 to 4
<from output port #>: 1 to 4
<to output port #>: 1 to 4
<from output port #> shall be inferior or equal to <to output port #>

Example: Connect input 2 to outputs 1, 2, and 3

connect -i 2 -o 1..3

Response: **[2,2,2,0]**
(or an error message if the command failed)

connect -json “[<input port #1>,<input port #2>,..., <output port #4>]”

Description: Make 4 connections/disconnections in one command using json format

Arguments: <input port #>: 1 to 4 to specify the input port to connect to, or 0 to disconnect it

Example: Connect input 2 to outputs 1, 2, and connect input 3 to outputs 4, and disconnect all other outputs.

connect -json “[2,2,0,3]”

Response: **[2,2,0,3]**
(or an error message if the command failed)

connect -p <preset #>

Description: Apply all connections defined in the selected preset #

Arguments: <preset #>: 1 to 8 to specify the preset to use

Example: Apply the connections defined in preset 7

connect -p 7

Response: **[2,0,0,3]**
(or an error message if the command failed)

3. Disconnection

disconnect -i <input port #>

Description: Disconnect a specific input port from all output ports connected to it

Arguments: <input port #>: 1 to 4

Example: Disconnect input 3 from all outputs connected to it

disconnect -i 3

Response: [2,0,2,2]

(or an error message if the command failed)

disconnect -o <output port #>

Description: Disconnect a specific output port from the input ports connected to it

Arguments: <output port #>: 1 to 4

Example: Disconnect output 3 from the input connected to it

disconnect -o 3

Response: [2,0,0,0]

(or an error message if the command failed)

disconnect -all

Description: Disconnect all output ports

Arguments: <none>

Example: Disconnect all outputs

disconnect -all

Response: [0,0,0,0]

(or an error message if the command failed)

4. EDID

edidcopy -p <predefined edid>

Description: Copy the specified predefined EDID values to all input ports

Arguments: <predefined edid>: 1080p3d, 1080p, 1080i, 1080p51, 1080p71

Example: Copy the specified predefined EDID 1080p to all input ports

edidcopy -p 1080p

Response: EDID:["input all","1080p"]

edidcopy -o <output port #> **-i** <input port #>

Description: Copy EDID from the specified output port to the specified input port

Arguments: <input port #>: 1 to 4

<output port #>: 1 to 4

Example: Copy EDID from the output port # 3 to the input port # 1

edidcopy -o 3 -i 1

Response: EDID:["input 1","output 3"]

4. EDID (Continued)

edidcopy -o <output port #>

Description: Copy EDID from the specified output port to all input ports

Arguments: <output port #>: 1 to 4

Example: Copy EDID from the output port # 2 to all input ports

edidcopy -o 2

Response: **EDID:["input all", "output 2"]**

5. Get

get -i <input port #>

Description: Get the connection state of a specific input port

Arguments: <input port #>: 1 to 4

Example: Get connection state of input port 2

get -i 2

Response: **Input 02 connected to: 01**

(or an error message if the command failed)

get -i

Description: Get the connection state of all input ports

Arguments: <none>

Example: Get connection state of all input ports

get -i

Response: **Input 01 connected to: none**

Input 02 connected to: 01

Input 03 connected to: none

...{and so on}

(or an error message if the command failed)

get -json

Description: Get all the output connection states in json format

Arguments: <none>

Example: Get all output connections states in json format.

get -json

Response: **[3,7,0,0]**

(or an error message if the command failed)

get -o <output port #>

Description: Get the connection state of a specific output port

Arguments: <output port #>: 1 to 4

Example: Get connection state of output port 4

get -o 4

Response: **Output 04 connected to: 1**

(or an error message if the command failed)

5. Get (Continued)

get -o

Description: Get the connection state of all output ports

Arguments: <none>

Example: *Get connection state of all output ports*

get -o

Response: **Output 01 connected to: 03**

Output 02 connected to: 04

Output 03 connected to: none

...{and so on}

(or an error message if the command failed)

6. Help

help or ?

Description: Display all the command list definition available

Arguments: <none>

Example: *Display all the command list*

help

?

Response:

```
connect
  connect -i <input port #> -o <output port #> {Connect 1 input port to 1 output port}
  connect -i <input port #> -o all {Connect 1 input port to all output port}
  connect -i <input port #> -o <from output port #>..<to output port #> {Connect 1 input port to a specific range of output port}

disconnect
  disconnect -i <input port #> {Disconnect 1 input port}
  disconnect -o <output port #> {Disconnect 1 output port}
  disconnect -all {Disconnect all input/output port}
  ... {and so on}

version
  version <no parameters> {Get the current firmware version}
```

7. Name

name -i <input port #> "<name>"

Description: Set a name for the selected input port

Arguments: <input port #>: 1 to 4
<name>: up to 20 characters

Example: Set name "My DVD Player" for input port 4

name -i 4 "My DVD Player"

Response: **Input Names: ["Input 1", "Input 2", "Input 3", "My DVD Player"]**
(or an error message if the command failed)

name -i

Description: Get a list of all the input port names

Arguments: <none>

Example: Get list of all input port names

name -i

Response: **Input Names: ["Input 1", "Input 2", "Input 3", "My DVD Player"]**
(or an error message if the command failed)

name -o <output port #> "<name>"

Description: Set a name for the selected output port

Arguments: <output port #>: 1 to 4
<name>: up to 20 characters

Example: Set the name "Kitchen TV" for output port 4

name -o 4 "Kitchen TV"

Response: **Output Names: ["Output 1", "Output 2", "Output 3", "Kitchen TV"]**
(or an error message if the command failed)

name -o

Description: Get a list of all the output port names

Arguments: <none>

Example: Get list of all output port names

name -o

Response: **Output Names: ["Output 1", "Output 2", "Output 3", "Kitchen TV"]**
(or an error message if the command failed)

name -preset <preset #> "<name>"

Description: Set a name for the selected preset number

Arguments: <preset #>: 1 to 8
<name>: up to 20 characters

Example: Set name "Week-end" for preset 7

name -preset 7 "Week-end"

Response: **Preset Names: ["Preset 1", "Preset 2", "Preset 3", "Preset 4", "Preset 5", "Preset 6", "Week-end", "Preset 8"]**
(or an error message if the command failed)

7. Name (Continued)

name -preset

Description: Get a list of all the preset names

Arguments: <none>

Example: Get list of all preset names

name -preset

Response: **Preset Names:**["Preset 1", "Preset 2", "Preset 3", "Preset 4", "Preset 5",
"Preset 6", "Week-end", "Preset 8"]

(or an error message if the command failed)

name -unit "<name>"

Description: Set a name for the unit

Arguments: <name>: up to 20 characters

Example: Set the name "MuxLab Switch" for the unit

name -unit "MuxLab Switch"

Response: **Unit Name:**["MuxLab Switch"]

(or an error message if the command failed)

name -unit

Description: Get the unit name

Arguments: <none>

Example: Get the unit name

name -unit

Response: **Unit Name:**["MuxLab Switch"]

(or an error message if the command failed)

8. Network

network

Description: Get the network address values (IP, mask and gateway)

Arguments: <none>

Example: Get network address values

network
Response: **IP: 10.0.1.101**
MASK: 255.255.0.0
GATEWAY: 10.0.0.1
DHCP: ON
(or an error message if the command failed)

Network -ip <ip address>

Description: Set a specific IP address (note that DHCP must be disabled to perform this action)

Arguments: <ip address>: #.#.#.#

Example: Set the IP address to 192.25.80.13

Network -ip 192.25.80.13
Response: **IP: 192.25.80.13**
MASK: 255.255.0.0
GATEWAY: 10.0.0.1
DHCP: OFF
(or an error message if the command failed)

Network -m <mask address>

Description: Set a specific mask address (note that DHCP must be disabled to perform this action)

Arguments: <mask address>: #.#.#.#

Example: Set the mask address to 255.255.255.0

Network -m 255.255.255.0
Response: **IP: 192.25.80.13**
MASK: 255.255.255.0
GATEWAY: 10.0.0.1
DHCP: OFF
(or an error message if the command failed)

Network -g <gateway address>

Description: Set a specific gateway address (note that DHCP must be disabled to perform this action)

Arguments: <gateway address>: #.#.#.#

Example: Set the gateway address to 10.101.1.5

Network -g 10.101.1.5
Response: **IP: 192.25.80.13**
MASK: 255.255.255.0
GATEWAY: 10.101.1.5
DHCP: OFF
(or an error message if the command failed)

8. Network (Continued)

Network -dhcp <dhcp state>

Description: Enable/disable DHCP feature

Arguments: <dhcp state>: on or off

Example: Enable the DHCP feature

Network -dhcp on

Response: **IP: 10.0.1.101**

MASK: 255.255.0.0

GATEWAY: 10.101.1.5

DHCP: ON

(or an error message if the command failed)

9. Password

password -wadmin <web admin password>

Description: Set the web server 'Admin' password

Arguments: <web admin password>: alphanumeric (max. length 20)

Example: Change the web admin password to new123

password -wadmin new123

Response: **Web server Admin password set successfully**

(or an error message if the command failed)

password -wuser <web user password>

Description: Set the web server 'User' password

Arguments: <web user password>: alphanumeric (max. length 20)

Example: Change the web user password to new123

password -wuser new123

Response: **Web server User password set successfully**

(or an error message if the command failed)

10. Preset

preset -s <preset #>

Description: Save the current connection in the selected preset

Arguments: <preset #>: 1 to 8

Example: Save current connection in preset 5

preset -s 5

Response: **preset 5 saved successfully**

(or an error message if the command failed)

11. Reset

reset -f

Description: Reset the unit and restore it to its factory settings

Arguments: <none>

Example: Reset unit and restore it to factory settings

reset -f

Response: “Clearing flash memory...
Rebooting...”

(or an error message if the command failed)

12. Sending Data

senddata -p <port #> -b <baud rate> -d “<data to send >”

Description: Send pass through data to a specific output port

Arguments: <port # >: 1 to 4

<baud rate>: 9600, 19200, 38400, 57600 or 115200

<data to send>: Hex string (max 80 characters)

Example: Send the following 4 bytes to port #3 0xA1, 0x55, 0xF2, and 0xC8

senddata -p 3 -b 9600 -d “A155F2C8”

Response: **[“0304A1B2C3D4”]**

Where:

03 = port number

04 = data length that follows (max value 0x28 bytes.)

A1B2C3D4 = data in hexadecimal (0xA1, 0xB2, 0xC3, 0xD4)

Command performed successfully

(or an error message if the command failed)

12. Status of the serial output port

serialdata -o <port #> <port state >

Description: Enable/Disable serial port for specific output port

Arguments: <port # >: 1 to 4

<port state>: on or off

Example: Disable serial port of output 3

serialdata -o 3 off

Response: **Serial Data Status : [1,1,0,1]**

(or an error message if the command failed)

13. Serial Port

serial

Description: Get all RS-232 settings

Arguments: <none>

Example: Get all RS-232 settings

serial

Response: **Baud Rate: 9600**

Data bits: 8

Stop bit: 1

Parity: NONE

(or an error message if the command failed)

serial -b <baud rate>

Description: Set the RS-232 baud rate

Arguments: <baud rate>: 9600, 19200, 38400, 57600 or 115200

Example: Set the RS-232 baud rate to 115200

serial -b 115200

Response: **Baud Rate: 115200**

Data bits: 8

Stop bit: 1

Parity: NONE

(or an error message if the command failed)

serial -o <data bits> <parity> <stop bits>

Description: Modify other RS-232 settings

Arguments: <data bits>: 7 or 8

<parity>: e, o or n (i.e: even, odd, none)

<stop bits>: 1 or 2

Example: Set the RS-232 settings to 8 data bits, no parity and 1 stop bit

serial -o 8 n 1

Response: **Baud Rate: 115200**

Data bits: 8

Stop bit: 1

Parity: NONE

(or an error message if the command failed)

serial -b <baud rate> -o <data bits> <parity> <stop bits>

Description: Modify all RS-232 settings

Arguments: <baud rate>: 9600, 19200, 38400, 57600 or 115200

<data bits>: 7 or 8

<parity>: e, o or n (i.e: even, odd, none)

<stop bits>: 1 or 2

Example: Set the RS-232 settings to a baud rate of 9600, 8 data bits, no parity and 1 stop bit

serial -b 9600 -o 8 n 1

Response: **Baud Rate: 9600**

Data bits: 8

Stop bit: 1

Parity: NONE

(or an error message if the command failed)

14. Status

status

Description: Display the unit status

Arguments: <none>

Example: *Display the unit status*

status

Response: **Temperature: 28 Celsius**

Voltage monitors: Ok

(or an error message if the command failed)

15. Version

version

Description: Get the current firmware version

Arguments: <none>

Example: *Get current firmware version*

version

Response: **Master firmware version: 1.0.0**

(or an error message if the command failed)

B. IP Control Commands

1. Notice

This section is provided for informational purposes only, and should only be used by software developers with a thorough understanding of the HTTP and JSON specifications.

2. Introduction

The Matrix Switch can be controlled using basic IP commands. These commands are based on the JSON format and are sent and received in standard TCP/IP packets. To learn more about JSON, visit <http://www.json.org>.

Only four types of JSON arrays are used to control the product:

Array of a single integer: [2]
Array of multiple integers: [1,2,3,4]
Array of a single string: ["A Name"]
Array of multiple strings: ["Name 1", "Name 2", "Name 3", "Name 4"]

Any other notation is not permitted. Also, "null" values are not permitted. Use 0 instead.

3. Basic Usage

All read and write operations are performed via HTTP GET and HTTP POST commands, respectively. While you can perform a GET at any time, a POST command will require prior authentication.

4. Basic Authentication

Authentication is performed in two simple steps:

1. Obtain a Session ID

Perform a **GET** request on **/var/session.json** to obtain a new session ID. The return value will be a JSON array of a single integer, for example **[12345]**. From then on, simply append the session to any new IP requests to use this session, e.g., **GET /var/conn.json?sid=12345**

2. Obtain Credentials for that Session ID

There are three permission levels that can be used to read/modify properties. These are:

- 0 – Guest: Can read all values. Cannot write or make changes.
- 1 – User: Same as Guest, but can change matrix video connections.
- 2 – Admin: Can perform any command without restriction.

To obtain credentials, you will need to POST an array of two strings to **/var/auth.json**: the userlevel, and the password associated to that user. For example:

POST /var/auth.json?sid=12345

POST data: **["2", "mypassword"]**

4. Basic Authentication (Continued)

If successful, you will receive an **HTTP 201 Created** response.

Sessions will automatically close after 5 minutes of inactivity. They may also be closed at any time by a **GET /var/logout.json**.

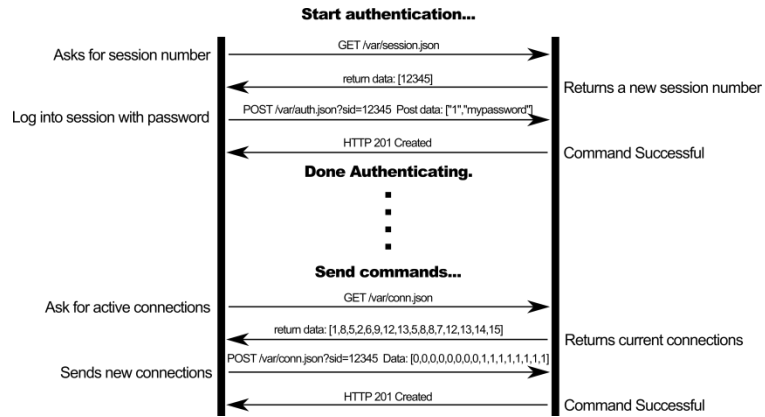

5. GET Commands

URL	Response
/var/conn.json	Array of 4 integers. Contains 4 items for the 4 displays. Each number is the source connected to the associated display. 0 means a display is disconnected. In the example below, Display 1 is disconnected, Display 2 is connected to Source 3, etc. Example: [0,3,2,4]
/var/pre1.json /var/pre2.json /var/pre3.json /var/pre4.json /var/pre5.json /var/pre6.json /var/pre7.json /var/pre8.json	Array of 4 integers. Provide the connections state of the corresponding preset. Contains 4 items for the 4 displays. Each number is the source connected to the associated display. 0 means a display is disconnected. In the example below, Display 1 is disconnected; Display 2 is connected to Source 3, etc. Example: [0,3,2,4]
/var/boxname.json	Array of a single string. Contains the name of the box. Example: ["Classroom B Matrix"]
/var/sources.json	Array of 4 strings. Contains the names of all 4 input ports. Example: ["Cable Box", "Satellite Receiver", "Demo Reel", ...]
/var/displays.json	Array of 4 strings. Contains the names of all 4 output ports. Example: ["Conference Room", "Cafeteria", ...]
/var/presetnames.json	Array of 8 strings. Contains the names of all 8 presets Example: ["Preset 1", "Preset 2", "week end", ...]
/var/dhcp.json	Array of a single integer. Indicate if dhcp is ON (1) or OFF (0) Example: [1]
/var/tempalarms.json	Array of 2 integers. Contains the Min. and Max. temperature of the unit before an alarm is raised Example: [5,70]
/var/auth.json	Array of a single integer. Contains an integer representing the current user level, from 0 to 2. Example: [2]
/var/session.json	Array of a single integer. Represents a new session ID Example: [3847534]
/var/logout.json	None. Destroys current session.
/var/mon_temp.json	Array of a single integer. Contains an integer representing the temperature inside the matrix, in degrees Celsius. Example: [26]
/var/mon_status.json	Array of a single integer. Represents the matrix status. 0 => Ok; 1 => fault; 2 => critical Example: [1]
/var/mon_voltages.json	Array of a single integer. Represents the voltage status. 1 => Ok; 0 => fault Example: [1]
/var/serial.json	Array of 4 integers. Contains the current serial port settings: baud rate, data bits(7 or 8), parity (0=>Even; 1=>Odd; 4=>None) ,stop bits (0=>1 stop bit; 2=>2 stop bits) Example: [9600,8,4,0]
/var/ip.json	Array of 4 integers. Contains the saved IP address (Not the current IP address being used) Example: [10,0,101,96]
/var/netmask.json	Array of 4 integers. Contains the saved mask address (Not the current mask address being used) Example: [255,255,0,0]
/var/router.json	Array of 4 integers. Contains the saved gateway address (Not the current one being used) Example: [10,0,1,1]
/var/alarmflags.json	Array of 8 integers. Contains the alarm configuration: beep, email, serial feedback, (the last 5 integer are not used) Example: [1,0,1,0,0,0,0,0]
/var/fwVersion.json	Array of 2 strings. Contains master firmware version Example: ["1.0.0", "0"]

6. POST Commands

POST commands will always return 1 of 5 HTTP headers:

HTTP 201 Created	Command was successful
HTTP 400 Bad Request	Received argument was malformed
HTTP 403 Forbidden	User does not have sufficient privileges
HTTP 404 Not Found	URL is incorrect
HTTP 501 Not Implemented	URL does not support receiving POST data

URL	Argument
/var/conn.json	Array of connections. (Same as GET above) Example: [0,1,2,3]
/var/pre1.json /var/pre2.json /var/pre3.json /var/pre4.json /var/pre5.json /var/pre6.json /var/pre7.json /var/pre8.json	Array of connections for a preset (Same as GET above) Example: [0,1,2,3]
/var/boxname.json	Array of a single string. Contains the name of the box, limited to 20 characters Example: ["Classroom B Matrix"]
/var/sources.json	Array of 4 strings. Contains the names of all 4 input ports. Example: ["Cable Box", "Satellite Receiver", "Demo Reel", ...]
/var/displays.json	Array of 4 strings. Contains the names of all 4 output ports. Example: ["Conference Room", "Cafeteria", ...]
/var/presetnames.json	Array of 8 strings. Contains the names of all 8 presets to be set Example: ["Preset 1", "Preset 2", "week end", ...]
/var/auth.json	Array of 2 strings. Contains a single digit string representing the user level requested, and a second string representing the password. Example: ["2", "myAdminPassword"]
/var/serial.json	Array of 4 integers. Set the following serial port settings: baud rate, data bits(7 or 8), parity (0=>Even; 1=>Odd; 4=>None) ,stop bits (0=>1 stop bit; 2=>2 stop bits) Example: [9600,8,4,0]
/var/ip.json	Array of 4 integers. Set the IP address Example: [10,0,101,96] WARNING! This request will actually take effect after the DHCP request will be sent
/var/netmask.json	Array of 4 integers. Set the mask address Example: [255,255,0,0] WARNING! This request will actually take effect after the DHCP request will be sent
/var/router.json	Array of 4 integers. Set the gateway address Example: [10,0,1,1] WARNING! This request will actually take effect after the DHCP request will be sent
/var/dhcp.json	Array of a single integer. Set the DHCP state ON ([1]) or OFF ([0]) Example: [1]
/var/tempalarms.json	Array of 2 integers. Set the Min. and Max. temperature of the unit before an alarm is raised Example: [5,70]
/var/alarmflags.json	Array of 8 integers. Set the alarm configuration: beep, email, serial feedback, (the last 5 integer are not used) Example: [1,0,1,0,0,0,0,0]
var/pass_admin.json	Array of 2 strings. Set the web administrator password Example: ["old admin password", "new admin password"]
var/senddata	Hexadecimal data string to send in the request formatted as follow: Example: ["03060A010203040506070809A0"] 03 is the port number (here it is port # 3) 06 is the baud rate code: <ul style="list-style-type: none"> > For 9600 the code is 06 > For 19200 the code is 08 > For 38400 the code is 09 > For 57600 the code is 0B > For 115200 the code is 0C 0A is the data length that follows (max value 0x28 bytes.) 01A203040506070809A0 is the data in hexadecimal (0x01, 0xA2, 0x03,...)

	The response will be the data (in hexadecimal) returned if any: ["A105.....450C"]
var/edidcopy_p.json	Array of a single integer. Copy the specified predefined EDID values to all input ports. The different code value are: 1 : 1080p3D 2 : 1080p 3 : 1080i 4 : 1080p 5.1 5 : 1080p 7.1 Example to apply the predefined EDID "1080i": [3]
var/edidcopy_o.json	Array of 4 integers. Contains 4 items for the 4 sources. Each number is the output port (display) number that you want to copy the EDID from and copy it to the associated source. 0 means do nothing. In the example below, the EDID from the Display 2 will be copied to the source 3 and the EDID from the Display 4 will be copied to the source 1 Example: [4,0,2,0]
var/pass_user.json	Array of 2 strings. Set the web user password Example: ["old admin password", "new user password"]
var/reset	Reset the unit to factory settings

C. Infrared Remote Control Codes

Custom Code: 00FF

Code (hex)	Identification	
	Section	Button
41	Display 1	<
46		>
09		1
1D		2
1F		3
0D		4
11	Display 2	<
15		>
17		1
12		2
59		3
08		4
48	Display 3	<
4A		>
5E		1
06		2
05		3
03	4	
40	Display 4	<
02		>
18		1
44		2
0F		3
51		4

6. Product Warranty Policy

Items Under Warranty - Company Policy

MuxLab guarantees its products to be free of defects in manufacturing and workmanship for the warranty period from the date of purchase. If this product fails to give satisfactory performance during this warranty period, MuxLab will either repair or replace this product at no additional charge, except as set forth below. Repair and replacement parts will be furnished on an exchange basis and will be either reconditioned or new. All replaced parts and products become the property of MuxLab. This limited warranty does not include repair services for damage to the product resulting from accident, disaster, misuse, abuse, or unauthorized modifications or normal decay of battery driven devices. Batteries, if included with the product, are not covered under this warranty.

Limited warranty service can be obtained by delivering the product during the warranty period to the authorized MuxLab dealer from whom you purchased the product, or by sending it to MuxLab. MuxLab will not accept any such product for repair without a Return Material Authorization number (RMA#) issued by its Customer Service Department and a proof of purchase date. If this product is delivered to MuxLab by mail, you agree to assume risk of loss or damage in transit, to prepay shipping charges to the warranty service location, and to use the original shipping container or equivalent.

THE ABOVE LIMITED WARRANTY IS THE ONLY WARRANTY COVERING YOUR MUXLAB PRODUCT. THERE ARE NO OTHER WARRANTIES, EXPRESSED OR IMPLIED, INCLUDING WARRANTIES OF MERCHANTABILITY OR FITNESS FOR A PARTICULAR PURPOSE. SOME STATES DO NOT ALLOW LIMITATIONS ON IMPLIED WARRANTIES, SO THE ABOVE LIMITATION MAY NOT APPLY TO YOU.

IF THIS PRODUCT IS NOT IN GOOD WORKING ORDER, YOUR SOLE REMEDY SHALL BE REPAIR OR REPLACEMENT AS PROVIDED FOR ABOVE. IN NO EVENT SHALL MuxLab BE LIABLE TO YOU FOR ANY DAMAGES, INCLUDING ANY LOSS OF PROFITS, LOST SAVINGS, OR OTHER INCIDENTAL OR CONSEQUENTIAL DAMAGES ARISING OUT OF THE USE OF OR INABILITY TO USE THIS PRODUCT, EVEN IF MUXLAB OR AN AUTHORIZED MuxLab DEALER HAS BEEN ADVISED OF THE POSSIBILITY OF SUCH DAMAGES; NOR WILL MUXLAB BE LIABLE FOR ANY CLAIM BY ANY OTHER PARTY. SOME STATES DO NOT ALLOW THE EXCLUSION OR LIMITATION OF INCIDENTAL OR CONSEQUENTIAL DAMAGES FOR CONSUMER PRODUCTS, SO THE ABOVE LIMITATIONS OR EXCLUSIONS MAY NOT APPLY TO YOU. THIS WARRANTY GIVES YOU SPECIFIC LEGAL RIGHTS. YOU MAY ALSO HAVE OTHER RIGHTS WHICH MAY VARY FROM STATE TO STATE.

Warranty Periods

Any product found to be defective within three (3) months of invoice, including one (1) month shelf life, may be returned for replacement by a new unit or a satisfactory repair within one (1) month of receiving any returned product. The customer must provide MuxLab with the serial number and proof of purchase of the defective unit being returned. All R.M.A.'s issued are subject to inspection by MuxLab, and will be returned to customer if not properly package – units must be returned in original container or equivalent. MuxLab will not accept any such product for repair without an authorization for its Technical Support department and without a return authorization number issued by MuxLab Customer Service department. For credit & replace R.M.A., customer will be liable to pay replacement invoice if defective products are not returned. Product more than six months old, including shelf life.

The defective unit must be returned prepaid to MuxLab and then the unit will be repaired or if repair is not possible, replaced by an equivalent unit and returned to the customer within one (1) month of receiving any returned product. There is no charge for repair (parts and labor) during the full warranty period.

Items Defective and not under Warranty

For products which are no longer under warranty the policy is repair and return. An amount of 25% of the products published list price at the time of purchase will be charged. Customer must issue a purchase order to cover the cost of repair. Each unit will be returned to the customer within one (1) month from receipt of the unit by MuxLab. The defective unit must be returned prepaid to MuxLab. The repaired unit will be returned to the customer FOB MuxLab. The repaired unit has a 90 day warranty.



MuxLab Inc.
8495 Dalton Road
Mount Royal, Quebec
Canada H4T 1V5
Tel.: +1 (514) 905-0588 Fax: +1 (514) 905-0589
Toll Free (North America): 877 689-5228
URL: www.muxlab.com
E-mail: videoease@muxlab.com